

Accuphase

PRECISION SA-CD TRANSPORT

PRECISION MDS/D DIGITAL PROCESSOR

DP-1000 / DC-1000

- High-rigidity, high-precision SA-CD/CD drive
- HS-LINK output terminals
- Programmable playlists to change the track order
- Data disc playback
- Low SA-CD/CD drive placement for a low center of gravity

- MDS/D MDS++ D/A converter with 8 channels driven in parallel
- *Dual Direct Balanced Filter* with totally separate line and balanced signal paths
- Sampling frequency and quantization bit displays
- Abundant digital inputs, including HS-LINK and USB



SUPER AUDIO CD

COMPACT
disc
DIGITAL AUDIO

Strive for the best,



DP-1000

Precision SA-CD transport

Weight is perfectly balanced with a hefty SA-CD/CD drive and a large, high-efficiency toroidal transformer with independent mechanical system and signal processing placed in the center, a clean power source with 10 large power supply filtering capacitors on the left, and a digital signal processing unit on the right to allow for high-precision data reading.

deliver the best



DC-1000

Precision MDS digital processor

With the power supply's filtering capacitors and the large, high efficiency toroidal transformer with completely independent analog and digital circuitry in the front and the digital and analog circuitry in the back, the smart and efficient circuit arrangement precisely conveys the feeling in music.



DP-1000

Precision SA-CD transport

The DP-1000 is the culmination of Accuphase's 50-year pursuit of creating the ideal transporter. This high-rigidity, high-precision drive is equipped with a silent and elegant disc loading mechanism. The outer rotor brushless DC motor smoothly rotates the disc, while the newly developed dampers protect the pickup from vibrations. Incorporating a number of technological improvements like a low center of gravity and fortified frame alongside features like programmable playlists, the DP-1000 is the ideal transport to quietly and accurately read data.

The Technology of Precision

Accurate Reading

Vibration countermeasures in SA-CD/CD players that read audio data from rapidly rotating discs greatly impact sound quality. The DP-1000 uses a highly rigid 7.2 kg (15.9 lbs) SA-CD/CD drive mounted on a 3.8 kg (8.4 lbs) bottom plate to create a low center of gravity. This low center of gravity construction prevents the housing from wobbling while significantly reducing external vibrations from reaching the traverse mechanism. The traverse and disc loading mechanisms are interconnected using high-quality elastic dampers of two different hardnesses to reduce the magnification of natural resonances in the objective lens and actuator, thus improving reading precision.

Smooth disc loading

Carved from an aluminum block and then finished with a hard anodized aluminum and satin finish, the elegant and elaborate disc tray uses high-quality dual stay bearing shafts to open and close smoothly and quietly.

Quiet Operation

Creating a quiet listening environment is a vital component in enjoying music. The DP-1000 uses an outer rotor brushless DC motor to rotate discs. No mechanical contacts results in a highly reliable motor with such low vibration and operating noise that the quiet listening environment it creates will make you completely forget that you are in the presence of a rotating component.

Machined aluminum parts

The majority of parts in the DP-1000 are machined from aluminium blocks. These parts are machined on the scale of microns, almost fully eliminating any dimensional errors in assembly for smooth and quiet operation.

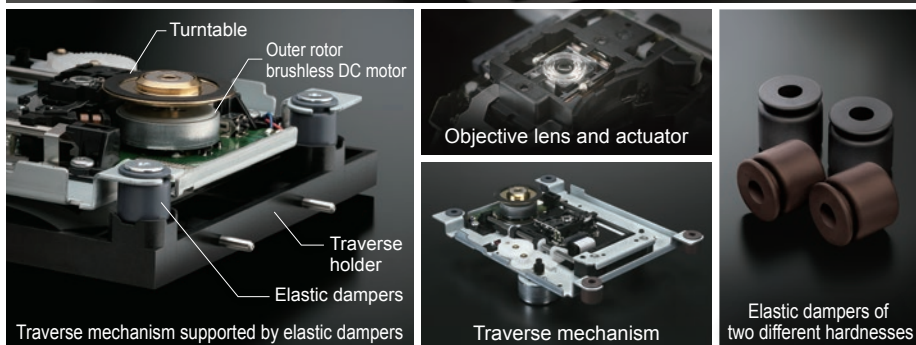
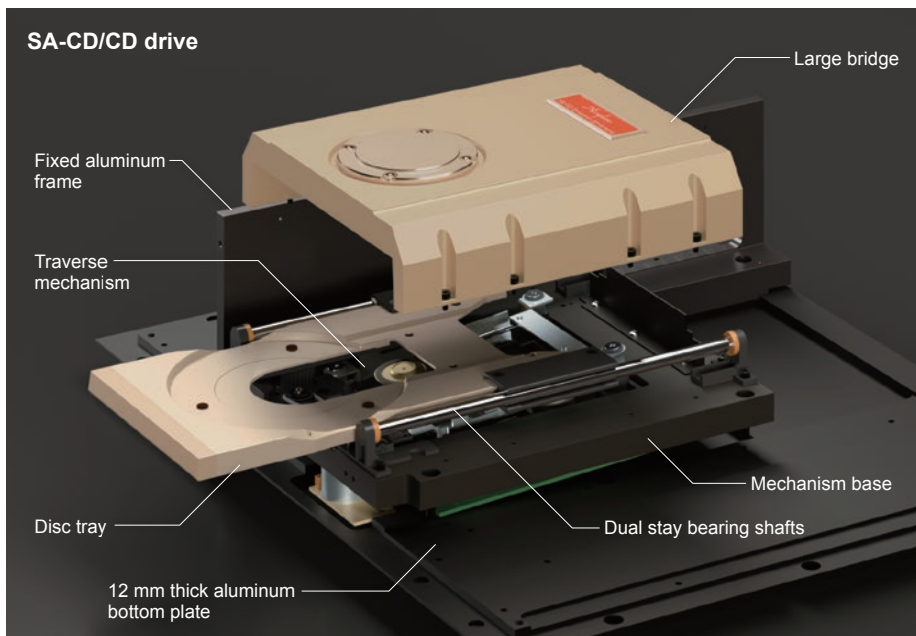
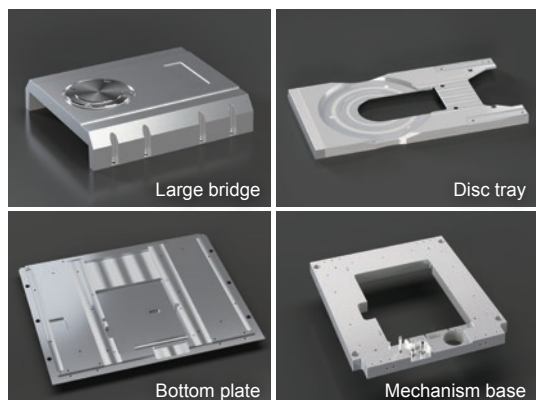

Internal layout

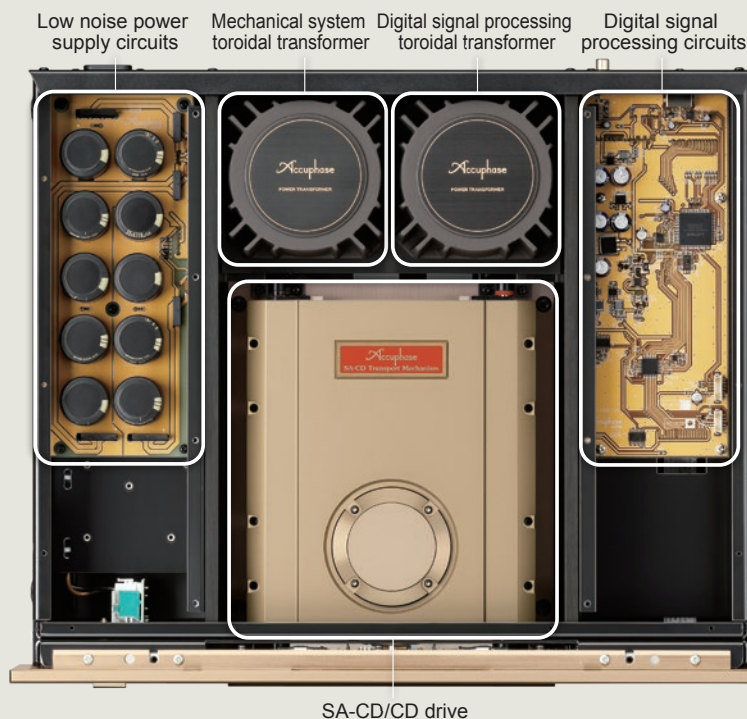

Advanced features

- High-rigidity, high-precision aluminum machined SA-CD/CD drive
- Low-noise power supply circuits and separate toroidal transformers for mechanical system and signal processing
- Programmable playlists so that you can enjoy your music in the order you want
- Accuphase voicing equalizer and digital connections
- Digital outputs (HS-LINK / COAXIAL)
- Low placement of the SA-CD/CD player for a low center of gravity
- "Power-on play" that automatically starts playback with a timer (sold separately)
- HS-LINK Ver. 1 / Ver. 2 switching
- Data disc playback (including DSD discs)
- Natural grain wood case with a mirror finish crafted by artisans using carefully selected virgin wood
- 12 mm thick machined aluminum bottom plate
- Advanced high-carbon cast iron insulators
- Supplied with HS-LINK cable AHDL-15

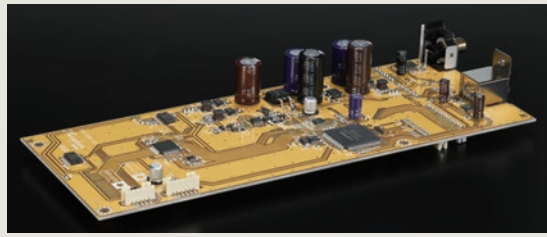

Digital signal processing circuits



Digital outputs



Toroidal transformers

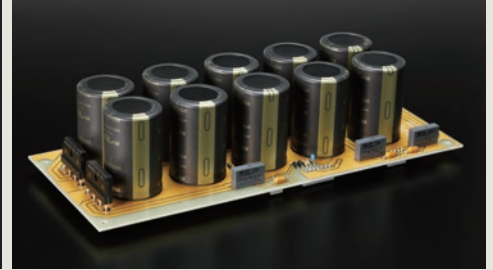

Low noise power supply circuits

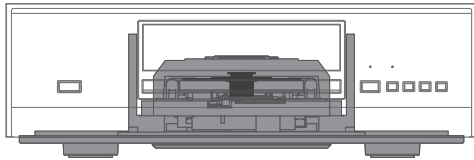

Low center of gravity



Advanced high-carbon cast iron insulators

HS-LINK cable AHDL-15 (supplied with the DP-1000)

The DP-1000 and the DC-1000 are connected via an HS-LINK cable. HS-LINK is Accuphase's original digital signal transmission standard.

*HS-LINK is a registered trademark of Accuphase Laboratory, Inc.

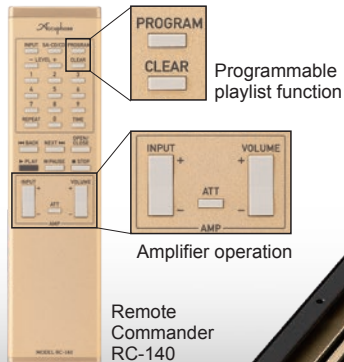

DC-1000

Precision MDSD digital processor

Accuphase celebrates 50 years of manufacturing with the DC-1000, a digital processor developed to deliver the ultimate in performance and sound quality. It is equipped with the ES9038 PRO (ESS Technologies) processor: an 8MDS (DSD signal) / 8MDS++ (PCM signal) type D/A converter that drives 8 channels in parallel to deliver almost 3 times more performance than single channel converters. Low-noise technologies refined during development of the amplifiers, like amplification of ANCC and internal signals and parallel arrangement of power circuits, allow the DC-1000 to deliver unprecedented levels of emotion.

The Technology of Precision

MDSD (Multiple Double Speed DSD) principle

DSD signals contain a large amount of quantization noise at frequencies higher than the range of human hearing, so digital filters have to be used to remove high frequency noise. Typically, DSD signals are converted into PCM signals before being input into the digital filter. The MDSD principle employed in the DC-1000, however, generates 8 phase-shifted DSD signals and then inputs them to the 8 channels in the MDS++ type D/A converter. The entire circuit then operates as a moving-average filter with completely linear phase characteristics to eliminate high frequency noise. MDSD represents a ground-breaking playback method that does not convert DSD signals into PCM signals, but instead operates as a filter that eliminates high frequency noise.

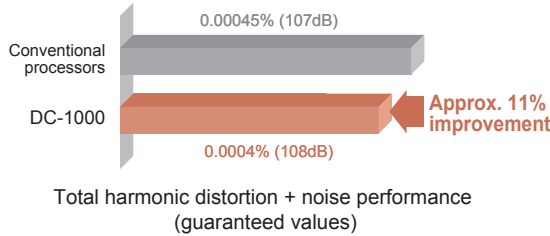

MDS++ (Multiple Delta Sigma) converter principle with 8 parallel channels

The MDS++ conversion principle is a revolutionary D/A conversion method that employs multiple delta-sigma type D/A converters connected in parallel for drastically improved performance. By passing output from the high-performance ES9038PRO (ESS Technologies) through 8 parallel converter channels, the DP-1000 provides a theoretical 2.8 ($=\sqrt{8}$) increase in overall performance for distortion, noise, linearity, and more. Because the improvements provided by the MDS++ principle are independent of signal frequency and level, output signal noise at very low levels can also be minimized, a feat that conventional delta-sigma converters find extremely difficult to achieve.



Newly developed Dual Direct Balanced Filter

The Dual Direct Balanced Filter is comprised of 2 parallel Direct Balanced Filters with totally separate line and balanced signal paths that suppress mutual interference to deliver improved performance and sound quality.

Glass cloth fluorocarbon resin substrate

The active filter amplifiers with Dual Direct Balanced Filter circuits use glass cloth fluorocarbon resin substrate, a material renowned for its sound quality and exceptional characteristics like low dielectric constant and minimum loss.

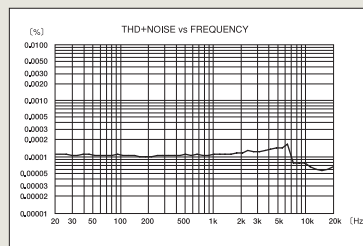
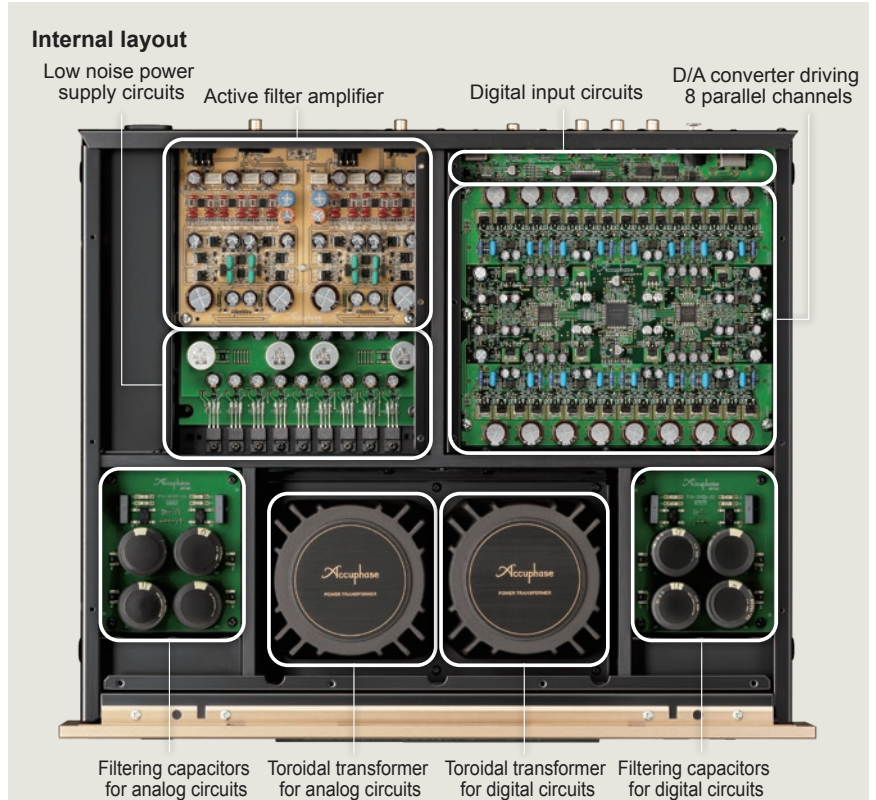

Total harmonic distortion (incl. noise) vs. frequency response

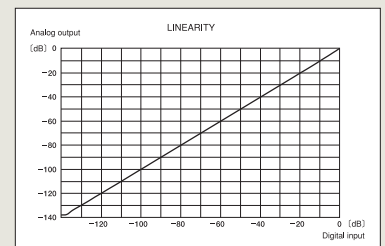

Linearity (digital input vs. analog output)

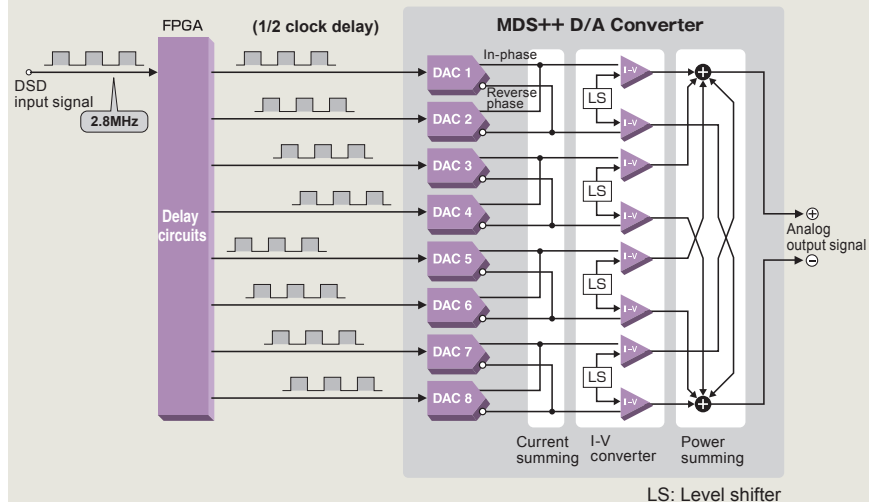

MDSD principle block diagram

Advanced features

- MDS / MDS++ D/A converter driving 8 parallel channels using ANCC
- Dual Direct Balanced Filter with completely separate line and balanced signals
- Separate toroidal transformers for analog and digital circuits
- Separate low noise power supply circuits for analog and digital circuits
- Display with sampling frequency and number of quantization bits
- Output level adjustments that can control different outputs from other players
- Digital interface for Accuphase Voicing Equalizer
- Abundant digital inputs like USBs, etc. to connect with computers (HS-LINK, USB, OPTICAL × 2, COAXIAL × 3, BALANCED)
- Digital outputs that can be used in digital recording (OPTICAL, COAXIAL)
- 2 (BALANCED, LINE) analog outputs
- Phase selector that can invert the balanced output
- Active filter amplifiers use glass cloth fluorocarbon resin substrate with low dielectric constant and minimum loss
- Natural grain wood case with a mirror finish crafted by artisans using carefully selected virgin wood
- 8 mm thick machined aluminum bottom plate
- Advanced high-carbon cast iron insulators
- High quality audio cable ASL-10B



Audio cable ASL-10B

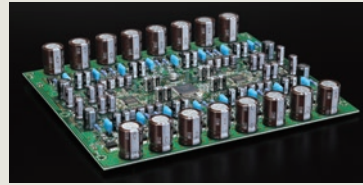

D/A converter driving 8 parallel channels

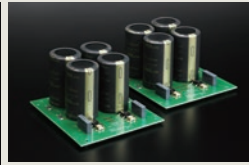

Cumulative 80,000µF filtering capacitors



Low noise power supply circuits



Digital input circuits



Sampling frequency and quantization bit display



Low value Standard value



Output level adjustment

Connection diagram

The DC-1000 is equipped with a plethora of inputs, allowing for simultaneous connections with multiple digital equipment. (Example: DP-1000, computer, CD player, TV, FM receiver, digital recorder)

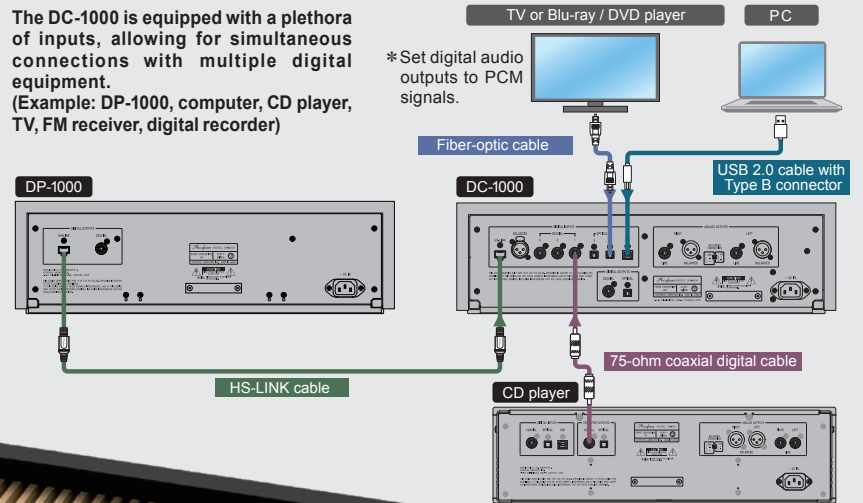

DP-1000 Front Panel

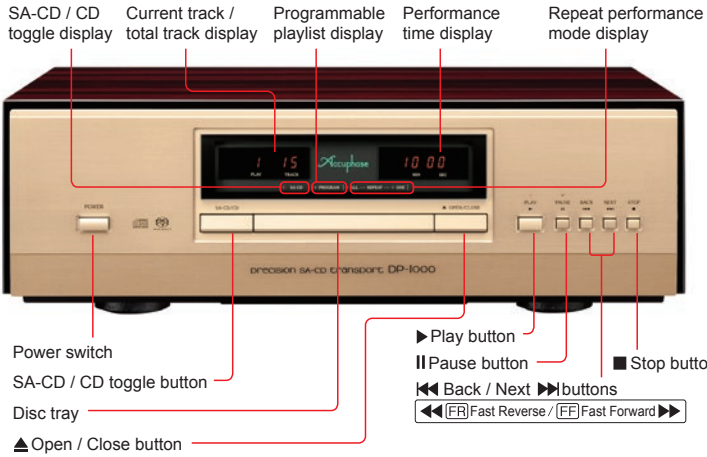

DC-1000 Front Panel

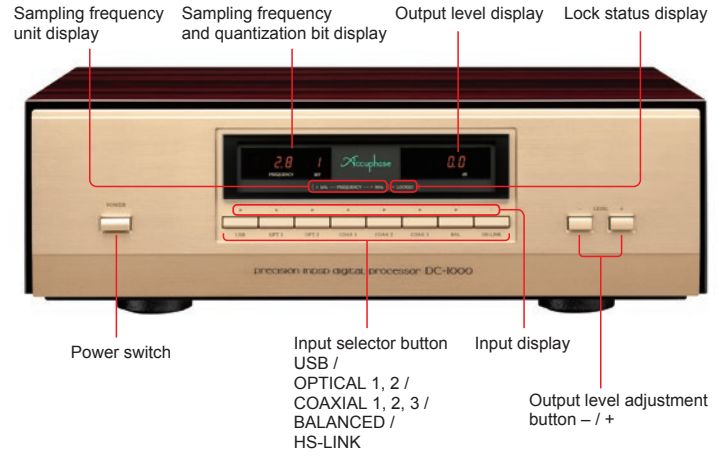

DP-1000 Rear Panel



DC-1000 Rear Panel

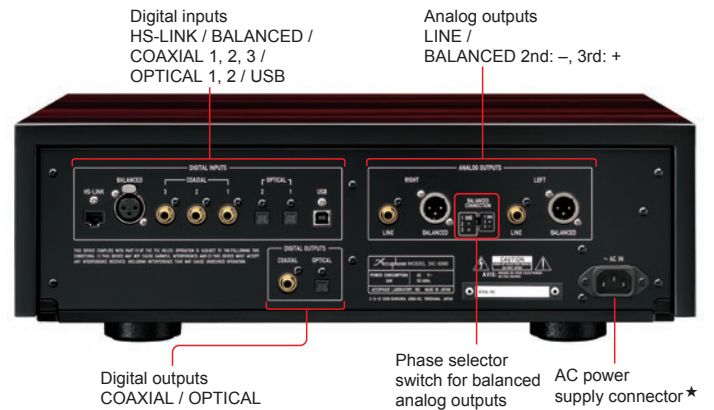

DP-1000 Guaranteed Specifications

[Guaranteed specifications measured according to the JEITA standard CP-2402A]

Compatible disc formats	2-channel Super Audio CD		
	CD		
	DSD disc	DVD-R / -RW / +R / +RW	DSF file format
Data read principle	Non-contact optical pickup		
Laser diode wavelength	SA-CD	655 nm	
	CD	790 nm	
Digital outputs	HS-LINK	Proprietary standard	Dedicated HS-LINK cable
	COAXIAL	IEC 60958 AES-3 compliant	75-ohm coaxial digital cable
Power requirements	120 V, 220 V, 230 V AC (voltage as indicated on rear panel)		50 / 60 Hz
Power consumption	16W		
Maximum dimensions	Width 477 mm (18.8 in) × Height 156 mm (6.1 in) × Depth 394 mm (15.5 in)		
Weight	Net	29.8 kg (65.7 lbs)	
	In shipping carton	37 kg (82 lbs)	

Supplied with DP-1000

- AC power cord
- HS-LINK cable AHDL-15 (1.5 m)
- Remote Commander RC-140
- Cleaning cloth

Supplied with DC-1000

- AC power cord
- Audio cable ASL-10B with plugs (1 m)
- USB Utility 3 CD
- Cleaning cloth

Optional HS-LINK cable

- HS-LINK cable AHDL-15 (1.5 m)
- HS-LINK cable AHDL-30 (3.0 m)

* AHDL-15 (supplied with DP-1000).
* AHDL-30 (available by special order).

Remarks

- ★ This product is available in versions for 120/220/230 V AC. Make sure that the voltage shown on the rear panel matches the AC line voltage in your area.
- ★ The 230 V version has an Eco Mode that switches power off after 120 minutes of inactivity.
- ★ The shape of the plug of the supplied AC power cord depends on the voltage rating and destination country.

DC-1000 Guaranteed Specifications

[Guaranteed specifications measured according to the JEITA standard CP-2402A]

Digital inputs	HS-LINK	Proprietary standard	Dedicated HS-LINK cable	
	BALANCED	IEC 60958 AES-3 compliant	110-ohm digital balanced cable	
	COAXIAL	IEC 60958 AES-3 compliant	75-ohm coaxial digital cable	
	OPTICAL	JEITA CP-1212 compliant	JEITA standard optical fiber cable	
Sampling frequencies	USB	USB 2.0 High-Speed (480 Mbps) standard		
	HS-LINK (Ver. 1)	DSD	2.8 MHz	1-bit
		PCM	32 / 44.1 / 48 / 88.2 / 96 / 176.4 / 192 kHz	16 to 24-bit
	HS-LINK (Ver. 2)	DSD	2.8 / 5.6 MHz	1-bit
		PCM	32 / 44.1 / 48 / 88.2 / 96 / 176.4 / 192 / 352.8 / 384 kHz	16 to 32-bit
	BALANCED	PCM	32 / 44.1 / 48 / 88.2 / 96 / 176.4 / 192 kHz	16 to 24-bit
		COAXIAL	PCM	32 / 44.1 / 48 / 88.2 / 96 / 176.4 / 192 kHz
	OPTICAL	PCM	32 / 44.1 / 48 / 88.2 / 96 kHz	16 to 24-bit
		USB	DSD	2.8 / 5.6 / 11.2 MHz (11.2 MHz: ASIO only)
	PCM		44.1 / 48 / 88.2 / 96 / 176.4 / 192 / 352.8 / 384 kHz	16 to 32-bit
D/A Converter	DSD	8 MDSLD principle		
	PCM	8 MDS++ principle		
Frequency response	0.5 to 50,000 Hz		+0, -3 dB	
Total harmonic distortion + Noise	0.0004%		20 to 20,000 Hz	
Signal-to-noise ratio	123 dB			
Dynamic range	121 dB			
Channel separation	120 dB			
Output voltage and impedance	BALANCED	2.5 V 50 ohms	Balanced XLR type	
	LINE	2.5 V 50 ohms	RCA phono jack	
Output level control	0 dB to -80 dB		1-dB steps	
			Digital	
Power requirements	120 V, 220 V, 230 V AC (voltage as indicated on rear panel)		50/60 Hz	
Power consumption	36 W			
Maximum dimensions	Width 477 mm (18.8 in) × Height 156 mm (6.1 in) × Depth 394 mm (15.5 in)			
Weight	Net	24.4 kg (53.8 lbs)		
	In shipping carton	32 kg (71 lbs)		