

Luxman

COMPACT DISC PLAYER

D-03X

Owner's Manual

Contents

Precautions	1
Features of This Unit.....	3
About Discs This Unit Can Play Back.....	5
Before Use	6
Names and Functions.....	8
Connections	17
Disc playback/pause/stop	19
Skip/Fast-forward/Rewind	21
Direct search/repeat playback	23
Program Playback	25
Random playback/disc information/zoom	27
Detailed Settings	29
Block Diagram	33
Specifications	34
Before Asking for Repair Service.....	35

Precautions

DO NOT move this unit during playback.

During playback, the disc is rotating at high speed. Do not try to lift or move this unit as the disc may be damaged.

When moving this unit

You must remove the disc and close the disc tray when moving this unit. Then, press the OPERATION button, and after confirming that the power of the unit is off, unplug the power cable from the AC outlet. If the unit is moved with a disc remaining inside, this can cause a malfunction.

Installation location

Install this unit in a location where good ventilation and heat radiation are assured.

Especially, installation of this unit where direct sunlight is present, where the temperature rises excessively high such as close to a heater, or where it is humid or dusty may cause a malfunction even if heat is efficiently released. Therefore, do not install this unit in such places.

Note:

For heat dispersal, do not install this equipment in a confined space such as a book shelf or similar unit.

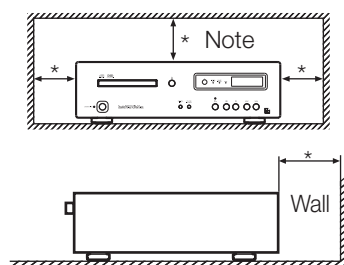

- Install the unit in a stable place such as in an audio rack.
- Do not install this unit near a television or color monitor.
- Keep this unit away from magnetically sensitive devices such as cassette decks.
- Install this unit on a level surface.

Avoid the following locations for installation

- Locations exposed to direct sunlight
- Locations subject to humidity and which lack ventilation
- Locations that are extremely hot or cold
- Locations which experience strong vibration
- Dusty locations
- Locations subject to oil, steam, and heat (such as kitchens)

Do not cover.

Do not cover or place any items or other units on top of this unit.

Avoid sources of heat

Do not place this unit on top of any device as an amplifier that may emit heat. If the unit is installed in a rack, install the unit below the shelf where an amplifier is installed, so as to avoid heat from the amplifier or other audio devices.

Turn off this unit when it is not used.

Depending on the condition of radio waves emitted during television broadcasting, interference fringes may appear on the television monitor, but that is not a malfunction. In such a case, turn off the unit. There may also be a case where noises are heard on the radio due to radio wave interference.

Notice when this unit is installed in a rack with glass doors

While the glass doors are closed, do not open the disc tray by pressing the open/close (▲) button of the remote control. Disc tray performance will be blocked, and that may result in a malfunction.

Condensation

In winter, be careful when carrying this unit from a cold place to a warm place or if the room temperature where this unit is installed is suddenly raised by a heater. The unit interior operating mechanism and lens may collect condensation. Under such conditions, this unit will not work normally and playback may be impossible. This depends on the amount of condensation. If the unit is turned on and left untouched for one to two hours, the operating temperature of this unit will dry any condensation.

Condensation can occur even in summer if this unit is directly exposed to cool air from an air conditioner. In such a case, the installation location should be changed.

Batteries

Warning: Batteries used for the remote control shall not be exposed to excessive heat such as sunshine, fire or the like.

How to handle discs

- Do not use any deficient discs (cracked, warped, etc.).
- Do not damage the signal surface of the disc or make it dirty.
- Do not place paper or a sticker on the disc. Such awkward handling can warp the disc and playback may become impossible. In many cases, rental discs carry labels and glue may leak from under the label. Before use, check that the disc is free from leaking glue or the like.
- Do not play two discs in a stack.
- Some discs with a printable surface, so-called "printable CD-Rs", easily stick to the mechanism which holds the CD during playback. Please do not use such discs as it may become impossible to eject the disc or cause a failure of the unit.

How to store discs

- Always put your discs in a case. Store them vertically where high temperature, high humidity, and direct exposure to sunlight are not prevalent. Places with extremely low temperature should also be avoided.
- Read the caution notes carefully that are attached to discs.

Disc cleaning

- If a disc is dirty with fingerprints or dust, this may affect sound quality. Lightly wipe the disc with soft cloth, from the inside to outer edge. (Don't wipe it with a circular motion.)
- Do not use a volatile chemicals such as benzine or thinners. Record spray, anti-static agents, and other such cleaners must not be used either.
- If a disc seems to be very dirty, dip soft cloth in water, wring it well, wipe away the dirt and finally remove the moisture with dry cloth.

Specifically designed discs

This unit cannot play discs with specifically designed shapes such as heart-shaped or hexagonal discs. Never use such discs as they can cause malfunctions.

Lens cleaning

If the lens gets dusty, discs may skip during playback. Please read "After-sales Services and Quality Assurance" and ask us for cleaning. Do not use any commercial cleaning discs available because they may damage the lens.

Notice on handling optical digital cables

- Do not fold the cables. For storage, wind each cable into a coil about 15 cm in diameter or larger.
- For connection, insert the cable connectors firmly into the terminals of this unit and the other devices.
- Only use 3 meter long cables or shorter.
- When the cable connectors get dusty, wipe the dust away with a dry soft cloth before inserting into the terminals.

Cleaning

- Usually, wipe the unit with a dry soft cloth. When the dirt is hard to remove, dip soft cloth in detergent diluted 5 or 6 times with water, wring it well, and remove contaminants. Then, remove the moisture with dry cloth.
- Do not use a solvent like alcohol, benzine, thinners, or chemicals because such a substance can damage the exterior. In addition, do not let this unit contact rubber or plastic foam for a long time. That may damage the cabinet surface of the unit.
- Before cleaning, unplug the power cable from the AC outlet.

Features of This Unit — CD player

Analog circuitry

This unit's improved audio quality amplifier circuitry drives the outputs from the D/A converters.

Texas Instruments DAC chips

This unit features Texas Instruments PCM1795 DAC chips in independent left and right dual monaural configuration.

USB input 384 kHz/32-bit supported

The USB B type input terminal makes it possible to input USB digital audio signals from a PC or Mac, supporting a sampling frequency of up to 384 kHz and 32-bit quantization.

USB input supports DSD

DSD format data from a PC, Mac or the like can be played via the USB terminal at sampling frequencies of 2.8 MHz, 5.6 MHz and 11.2 MHz.

Asynchronous communication supported

Very low jitter has been achieved using dedicated USB input ICs with asynchronous communication and PLL.

Digital input terminals

This unit is equipped with a coaxial input terminal and an optical input terminal. It is compatible with S/PDIF format signals between 44.1 kHz and 192 kHz.

Digital inputs (S/PDIF) with low jitter has been achieved using AK4118AEQ chips manufactured by Asahi Kasei Microdevices Corporation.

Digital audio signals from other audio devices are played back with significantly improved audio quality.

Aluminum construction

The base for the CD mechanism is made from 8 mm thick, solid machined aluminum. Chassis structure rigidity has been highly enhanced as well as the aluminum front panel.

MQA (Master Quality Authenticated)

MQA is an award-winning British technology that delivers the sound of the original master recording.

The master MQA file is fully authenticated and is small enough to stream or download.

Visit mqa.co.uk for more information.

This unit includes MQA technology, which enables you to play back MQA audio files and streams from all digital inputs, delivering the sound of the original master recording. D-03X is a CD player that can recognise an MQA-CD. The built-in MQA decoder will automatically restore the high-resolution signal heard in the studio and confirm it, using the authentication signature.

Low phase noise crystal oscillator

This unit uses an oscillator with low noise near the oscillating frequency.

This oscillator provides clocking with less jitter.

Last memory function

Built-in flash memory can memorize settings such as dimmer, digital input selection, etc.

Dimmer function

Display brightness can be adjusted with 4 brightness levels.

Digital output OFF

The digital audio output can be deactivated to improve the quality of the analog audio output.

Analog output terminals

18 mm gold plated RCA terminals support high-performance line cables with large plugs.

Analog output phase switching

Both balanced output and unbalanced output are phase switchable.

Zoom function

When the ZOOM button is pressed on the remote control, the track number and time information can be displayed enlarged.

5 playback modes

Playback mode can be selected from regular, programmed, playback, random, and repeat playback.

Original technologies

Our traditional, non-angled circuitry, OFC internal wiring, and original custom-made components are used throughout the unit.

Remote control (RD-28)

The remote control is encased in aluminum. Tactile switches will satisfy users with light key touch.

Highly stable power supply

The unit's highly stable power supply circuitry features a large capacity OI-core-type power transformer with custom designed 3,300 $\mu\text{F} \times 5$ blocking capacitors.

Schottky barrier diodes

By using Schottky diodes, manufactured by KYOCERA Corporation (former Nihon Inter Electronics Corporation), this unit achieves higher DC conversion efficiency in the rectifier circuit and much less switching noise.

LUXMAN's original OFC wiring

Our original OFC cable, with non-plated core wire, is used for internal wiring to achieve smooth signal transmission.

*1 Mac and Mac OS are trademarks of Apple Inc., registered in the U.S. and other countries.

*2 Windows is a registered trademark of Microsoft Corporation in the United States and/or other countries.

*3 DSD is a trademark.

*4 Sound Wave Logo is a registered trade mark of MQA Limited. ©2018

*5 MQA is a registered trade mark of MQA Limited. ©2018





*6 MQA-CD is a registered trade mark of MQA Limited. ©2017

*7 The described company names and product names are trademarks or registered trademarks of each company.

About Discs This Unit Can Play Back

Types of discs that can be played

The following marks are printed on disc labels, packages, or CD jackets.

Marks for types of discs this unit can play back			
			
Marks for types of discs this unit cannot play back			
			

This unit can play back 8 cm CDs without using an adapter.
Do not use an adapter for 8 cm CDs.

- CD-R/CD-RW discs that have been written by a recorder or PC may not be played back (due to characteristics of discs, scratches, dirt on discs, dirt on the lens of the unit, condensation, etc.).
- Discs written by a PC may not be played back depending on the application settings or environment. Write the discs in a proper format. (Refer to the distributor of application for details.)
- Time information may not be displayed when an unfinalized CD-R/CD-RW disc is played back.
- Refer to the precautions for discs for details on how to handle CD-R/CD-R discs.

Check the accessories

Whilst unpacking, check if the following accessories are included.

- Power cable
- Remote control (RD-28)

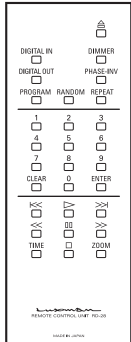

- "AAA" batteries (2 pieces)

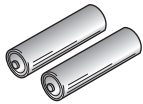

- Safety cautions
- Owner's Manual (This document)

How to Use Remote Control

Insert batteries into the remote control

1. Remove the battery cover on the rear of the remote control. Put your finger on the battery cover claw and slide the cover downward to remove the cover.
2. Put 2 AAA batteries in the battery case as shown in the illustration on the battery case in consideration of the polarity \oplus and \ominus .
3. In the reverse order of battery cover removal, put the battery cover back to the opening of the remote control and slide the cover upward until it clicks.

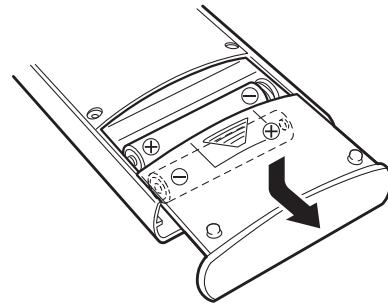

-
- Do not use a new battery and an old one together.
 - There may be a case in which the voltages are different between two batteries even though their shapes are the same. Do not use the batteries of different types together.
 - If the remote control is not used for a long time (more than 1 month), the batteries shall be removed from the case. If the battery liquid is leaking, wipe away the liquid from the case before inserting new batteries.
 - To discard exhausted batteries, follow the instructions of each local authority.
-

Before Use

Remote control's range

To use the remote control, aim it at the remote control infrared receiver on the front panel of main unit.

The effective distance is approx. 5 m from the main unit and at 30 ° to either side of the remote control infrared receiver.

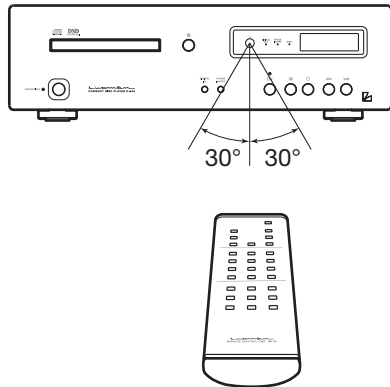

Effective distance:
approx. 5 meters

Do not expose the remote control infrared receiver to direct sunlight or strong light sources. That may cause malfunction.

Front panel

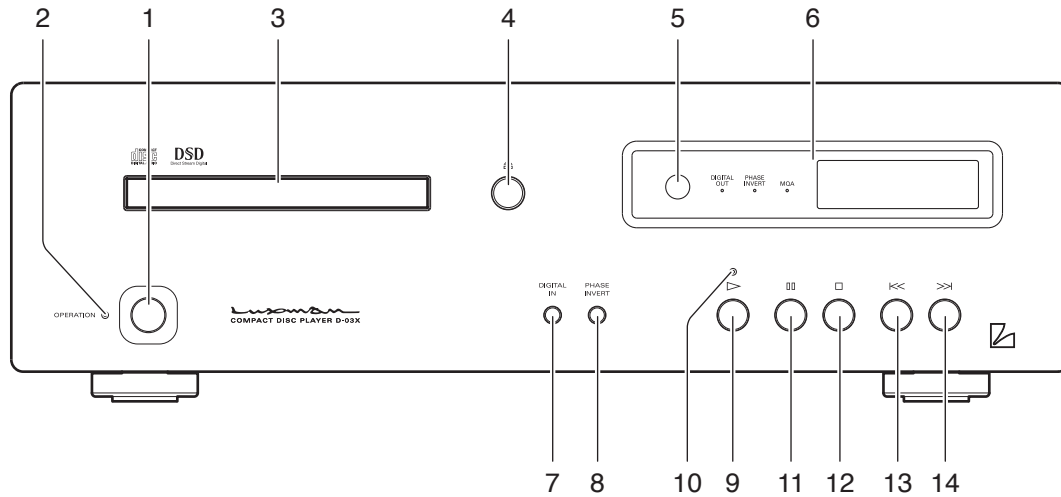

1. Operation button (OPERATION)

Toggles the power on and off.

When wiring or connection is performed, be sure to turn off this button.

2. Operation indicator (OPERATION)

Blinks during warm-up when the operation button is turned on and lights up when the operation state is activated afterward.

3. Disc tray

When inserting or removing a disc, this tray is opened or closed by pressing the open/close button (⏏).

4. Open/close button (⏏)

Opens or closes the disc tray.

5. Remote sensor (R)

Receives signals from the accessory remote control.

6. Display window

Displays the operation status of this unit.

This display is composed of 3 indicators and display tube.

Names and Functions

Front panel

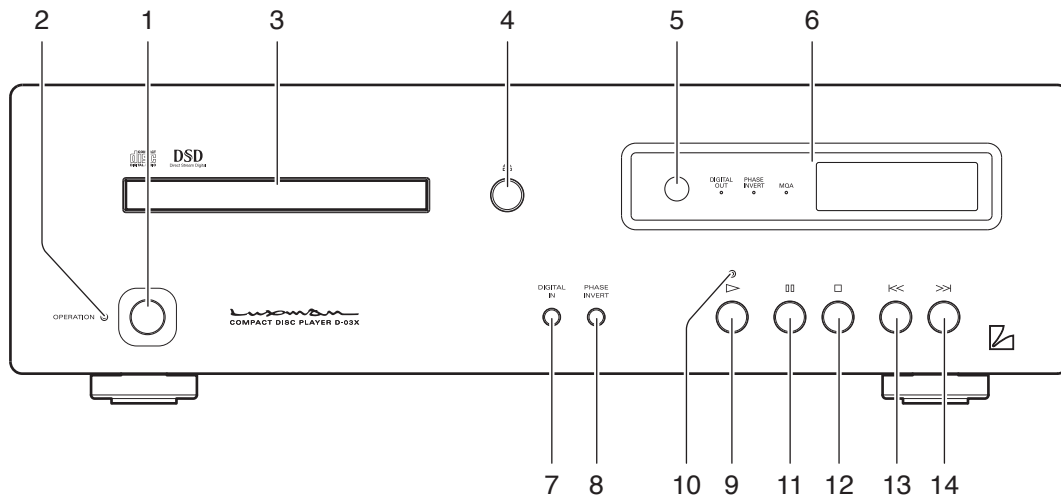

7. Digital input selection button (DIGITAL IN)

When using this unit as a D/A converter, press this button to select between coaxial, optical, USB, and CD player. Switchover is performed among coaxial, optical, USB, and CD player.

Holding down this button toggles the digital output on and off.

8. Phase invert button

The phase of the analog output on the rear panel can be inverted for both the balanced output and unbalanced output.

This setting is stored on the flash memory even when the power is turned off.

Every time this button is pressed, the phase changes as follows: NORMAL→INVERT→NORMAL→INVERT→ ...

[Phase Normal]

1. GROUND
2. COLD (-)
3. HOT (+)

[Phase Inverted]

1. GROUND
2. HOT (+)
3. COLD (-)

9. Play button (▶)

Plays back a disc.

10. Play indicator

Lights up while a disc is being played back. Blinks while playback is being paused.

11. Pause button (⏸)

When this button is pressed during playback, the playback stops. When this button is pressed again, the playback starts again. During pause, the play indicator blinks.

12. Stop button (⏹)

Stops playback.

13. Previous button (⏮)

Pushing this button returns playback to the beginning of track. When this button is pressed twice, playback returns to the beginning of previous track.

14. Next button (⏭)

When this button is pressed, the playback jumps to the beginning of next track.

Display window

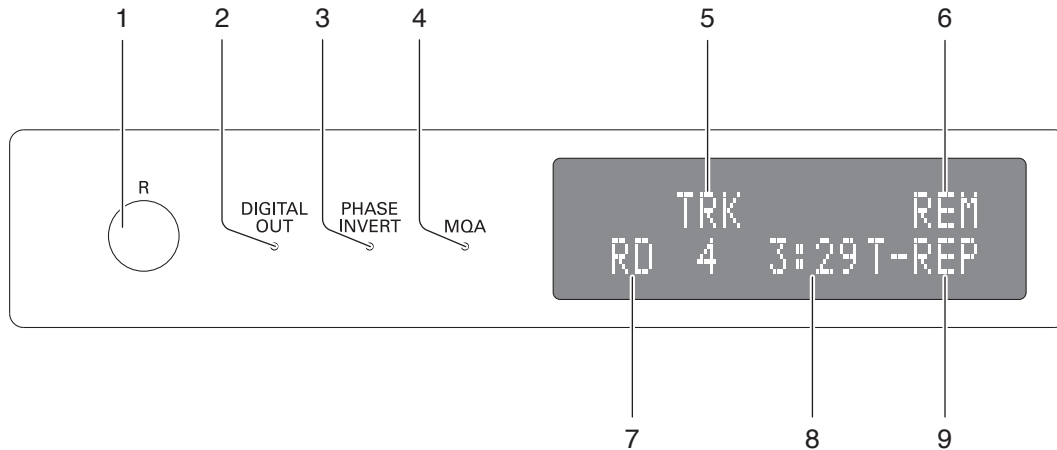

1. Remote control infrared receiver (R)

Receives the infrared signals from the remote control.

2. Digital output indicator (DIGITAL OUT)

Lights up when digital audio output is ON.

To toggle the digital output on and off, hold down the digital input selection button (DIGITAL IN) on the main unit.

3. Phase invert indicator (PHASE INVERT)

Lights up when the analog output phase is inverted, which is caused by pressing the phase invert button.

[Off (Phase Normal)]

1. GROUND
2. COLD (-)
3. HOT (+)

[On (Phase Inverted)]

1. GROUND
2. HOT (+)
3. COLD (-)

4. MQA indicator (MQA)

Lights up while an MQA-CD, an MQA file or stream is being played back

[Off]

It is not an MQA source

[Green Light]

It is indicating that the unit is decoding and playing an MQA stream or file and denotes provenance to ensure that the sound is identical to that of the source material.

[Blue Light]

It is indicating the unit is playing an MQA Studio file, which has either been approved in the studio by the artist/producer or has been verified by the copyright owner.

[Magenta Light]

It confirms that the product is receiving an MQA stream or file. This delivers the final unfold of the MQA file and displays the original sample rate.

5. Track number (TRK)

"TRK" is displayed above, and the track number is displayed below during playback.

6. Time display mode

The display shows different playback time modes. "REM" is displayed indicating the remaining time of the current track. "T-REM" is displayed indicating the total remaining time of disc. This display area does not light up when showing the elapsed time of a track.

Names and Functions

Display window

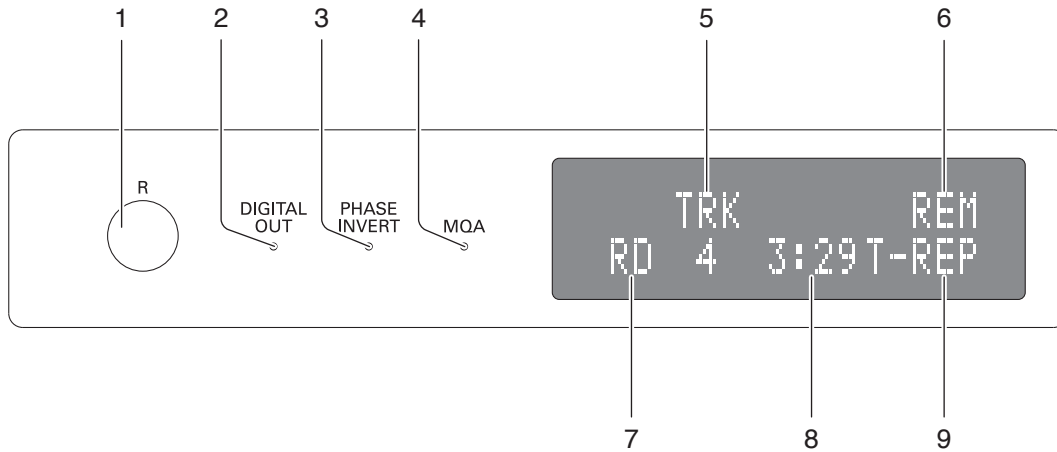

7. Playback mode

“RD” is displayed during random playback. “PG” is displayed during program playback. This display area does not light up during regular playback.

8. Time

Displays the elapsed time of current track, remaining time of current track, or remaining time of disc. Time display is switched over according to time display mode.

9. Repeat mode

Displays the mode for repeat playback. There are two types of repeat playback: track repeat (T-REP) and all repeat (A-REP).

Remote control

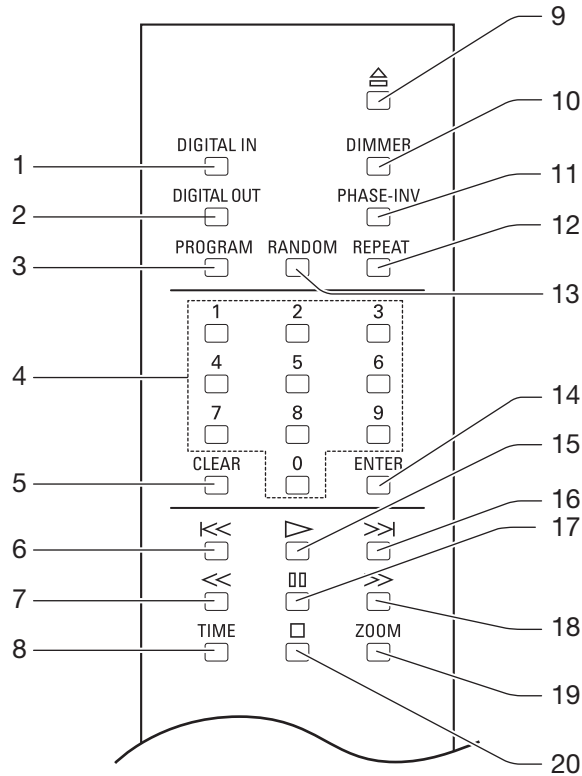

1. Digital input selection button (DIGITAL IN)

When using this unit as a D/A converter, press this button to select between coaxial, optical, USB, and CD player.

2. Digital output selection button (DIGITAL OUT)

Turns on/off the digital output (COAX/OPT).

3. Program button (PROGRAM)

Programs the track numbers to play back in a desired order.

4. Numeric keys (1, 2, 3, 4, 5, 6, 7, 8, 9, 0)

These keys are pressed to specify the track numbers for direct search or program.

5. Clear button (CLEAR)

Cancels the program settings.

6. Previous button (⏮)

Pushing this button returns playback to the beginning of track. When this button is pressed twice, playback returns to the beginning of previous track.

Names and Functions

Remote control

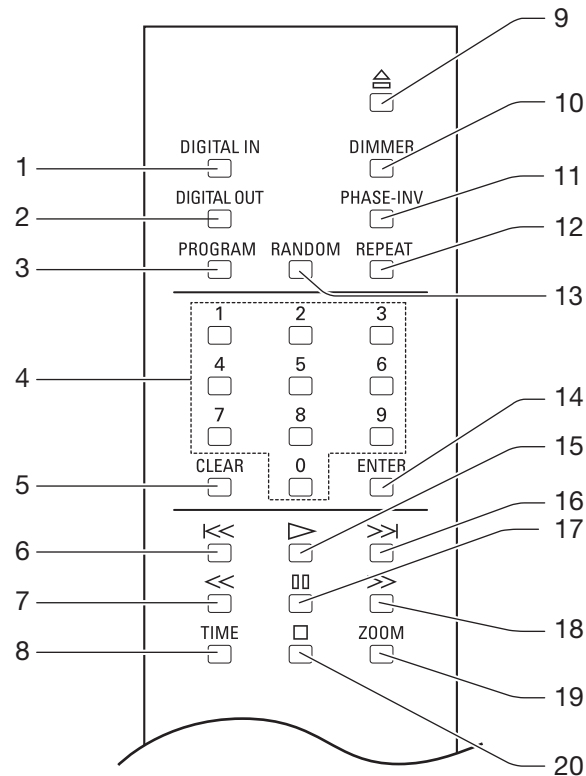

7. Rewind button (<<)

When this button is pressed during playback, the track will rewind until the button is released.

8. Time display button (TIME)

This button adjusts the time display mode between elapsed time of current track, remaining time of current track, or remaining time of disc.

9. Open/close button (☰)

Opens or closes the disc tray.

10. Dimmer button (DIMMER)

Adjusts the brightness of the main unit display. The brightness can be adjusted in 4 steps from light off to normal.

11. Phase invert button (PHASE-INV)

The phase of the analog output on the rear panel can be inverted for both the balanced output and unbalanced output.

This setting is stored on the flash memory even when the power is turned off.

Every time this button is pressed, the phase changes as follows: NORMAL→INVERT→NORMAL→INVERT→...

[Phase Normal]

1. GROUND
2. COLD (-)
3. HOT (+)

[Phase Inverted]

1. GROUND
2. HOT (+)
3. COLD (-)

12. Repeat button (REPEAT)

Pushing this button will enable repeat playback of the selected track or the whole disc. There are two types of repeat playback: track repeat (T-REP) and all repeat (A-REP).

13. Random button (RANDOM)

This button is pressed to perform random playback.

14. Enter button (ENTER)

Executes the set or selected items.

15. Play button (▶)

Plays back a disc.

16. Next button (▶|)

When this button is pressed, the playback jumps to the beginning of next track.

17. Pause button (⏸)

When this button is pressed during playback, the playback stops. When this button is pressed again, the playback starts again. During pause, the play indicator blinks.

18. Fast-forward button (⏩)

When this button is pressed during playback, the track will be fast-forwarded until the button is released.

19. Zoom button (ZOOM)

When this button is pressed during playback, the track number and time are displayed in an enlarged manner.

20. Stop button (⏹)

Stops playback.

Names and Functions

Rear panel

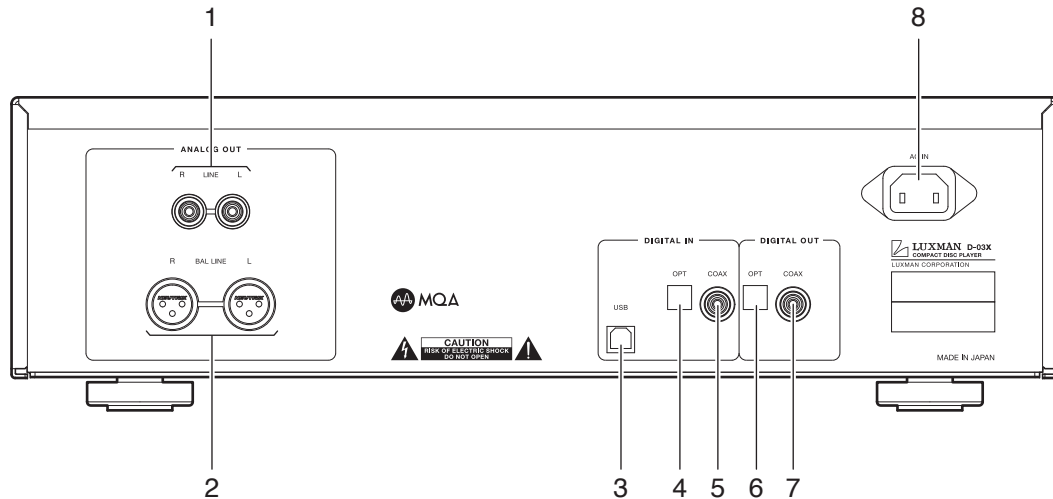

1. Unbalanced analog output terminals (LINE)

Use these RCA terminals to output unbalanced audio signals from this unit.

Connect these terminals to the unbalanced inputs of a unit such as an integrated amplifier using RCA cables.

The phase can be reversed with the analog output phase selection button (PHASE INVERT/PHASE-INV).

2. Balanced analog output terminals (BAL LINE)

Use these XLR output terminals to output balanced audio signals from this unit.

Connect these terminals to the balanced inputs of a unit such as a preamplifier using balanced XLR cables.

The following table shows the unit's XLR output terminals pin configuration:

[Phase Normal]

1. GROUND
2. COLD (-)
3. HOT (+)

[Phase Inverted]

1. GROUND
2. HOT (+)
3. COLD (-)

3. USB digital input terminal (USB)

Use this USB (B-type) input terminal for digital input signals from a PC or Mac using a USB cable.

The terminal supports the following signals.

- PCM signal

Sampling frequency : 44.1 kHz, 48 kHz, 88.2 kHz,
96 kHz, 176.4 kHz, 192 kHz,
352.8 kHz, 384 kHz

Quantization bit rate : 16-bit, 24-bit, 32-bit

- DSD signal

Sampling frequency : 2.8 MHz, 5.6 MHz, 11.2 MHz

Quantization bit rate : 1-bit

When using Windows OS, our dedicated driver software needs to be downloaded from the LUXMAN website and installed.

Refer to the "Driver Installation Manual" on the LUXMAN website for detailed information.

When using Mac OS, this unit is automatically recognized.

Caution:

Connection between a PC and this unit using a USB cable should not be performed before the installation of the dedicated driver software is completed. Failure to observe this may cause malfunction.

4. Optical digital input terminal (OPT)

The square optical input terminal should be used for digital signals from a CD player or other devices equipped with a digital output terminal using an optical digital cable.

The terminal supports the following PCM signal data.

Sampling frequency : 44.1 kHz, 48 kHz, 88.2 kHz,
96 kHz, 176.4 kHz, 192 kHz

Quantization bit rate : 16-bit, 20-bit, 24-bit

5. Coaxial digital input terminal (COAX)

The RCA digital input terminal should be used for digital input signals from a CD player or other devices equipped with digital output terminals using a coaxial digital cable.

The terminal supports the following PCM signal data.

Sampling frequency : 44.1 kHz, 48 kHz, 88.2 kHz,
96 kHz, 176.4 kHz, 192 kHz

Quantization bit rate : 16-bit, 20-bit, 24-bit

6. Optical digital output terminal (OPT)

Connect this terminal to a device such as a D/A converter or an amplifier that has a digital input terminal using an optical digital cable.

This terminal is a shutter-type optical terminal. Direct the cable connector correctly when inserting the cable into the terminal. If the cable connector is inserted forcibly in the wrong direction, the terminal may be deformed and the shutter may not close even after disconnecting the cable.

7. Coaxial digital output terminal (COAX)

Connect this terminal to a device such as a D/A converter or an amplifier that has a digital input terminal using a coaxial digital cable. However, this output will not reproduce PCM or DSD files played into the unit from a PC or Mac.

8. Power cable terminal (AC IN)

Connect the accessory power cable here to supply power from the AC outlet on the wall.

Connections

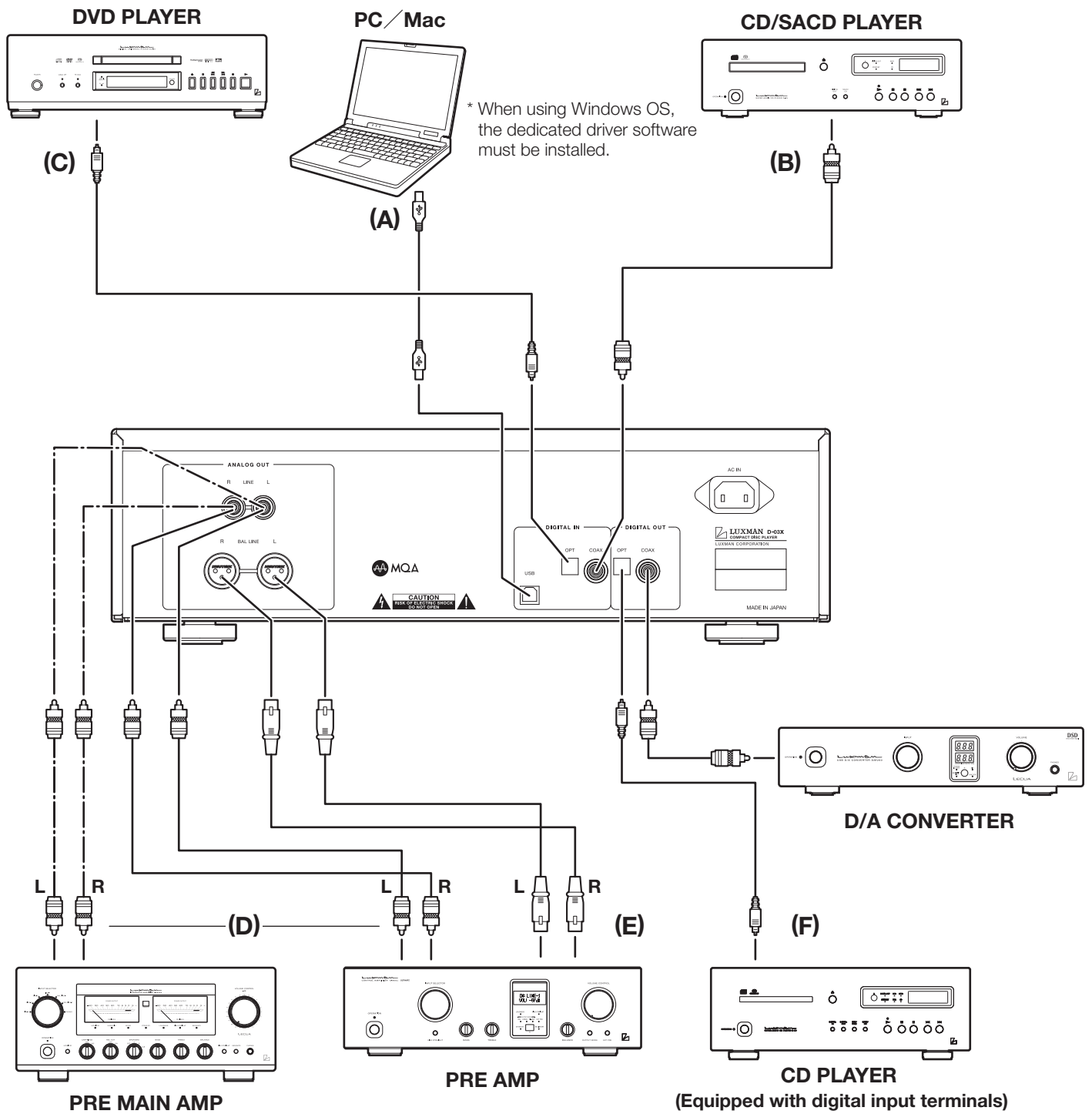

Before connecting

Before connecting other devices, connect the jack side of the accessory power cable to the AC inlet of this unit.

When connecting, turn off the power supply of this unit and the power supplies of auxiliary devices to prevent unexpected accidents that may be caused by noise.

Connecting to the power supply

Insert the accessory power supply cable plug into an AC outlet on the wall of the listening room.

How to connect input devices

1. Digital connection from a PC/Mac (Refer to the connection diagram (A).)

Connect between the USB (A-type) terminal of the PC or Mac and the USB (B-type) terminal of this unit with a USB cable.

When using Windows OS, the dedicated driver software needs to be downloaded from the LUXMAN website and installed.

Refer to the "Driver Installation Manual" on the LUXMAN website for detailed information.

When using Mac OS, this unit is automatically recognized.

Caution:

Connection between a PC and this unit using a USB cable should not be performed before the installation of the dedicated driver software is completed. Failure to observe this may cause malfunction.

2. Digital connection from a device such as a CD player (Refer to the connection diagrams (B) and (C).)

Connect between the (coaxial or optical) digital output terminal of a CD player, an SACD player, a DVD player or other such devices and the digital input terminal (COAX/OPT) of this unit with a coaxial digital cable and an optical digital cable.

This terminal is a shutter-type optical terminal. Direct the cable connector correctly when inserting the cable into the terminal. If the cable connector is inserted forcibly in the wrong direction, the terminal may be deformed and the shutter may not be able to close even after disconnecting the cable.

Upper side

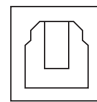

Lower side

The optical terminal is mounted as illustrated.

How to connect output devices

1. Unbalanced connection with a device such as an integrated amplifier (Refer to connection diagram (D).)

Connect between the unbalanced analog RCA output terminals of this unit and the unbalanced input terminals of a sound-volume-adjustable device such as an integrated amplifier using two RCA cables (L/R).

2. Balanced connection with a device such as a pre-amplifier (Refer to connection diagram (E).)

Connect between the balanced analog output terminals (BAL LINE) of this unit and the balanced input terminals of a device such as an integrated amplifier with two balanced XLR cables (L/R).

3. Digital output to a device such as another D/A converter (Refer to connection diagram (F).)

Connect between the digital output terminal (COAX/OPT) of this unit and a device such as a D/A converter or a unit equipped with digital input terminals with a coaxial digital cable or an optical digital cable.

Disc playback/pause/stop

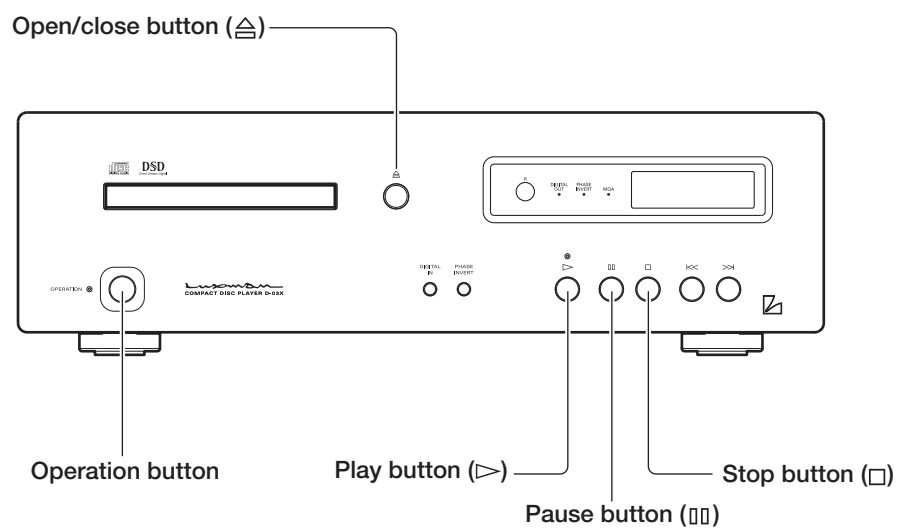
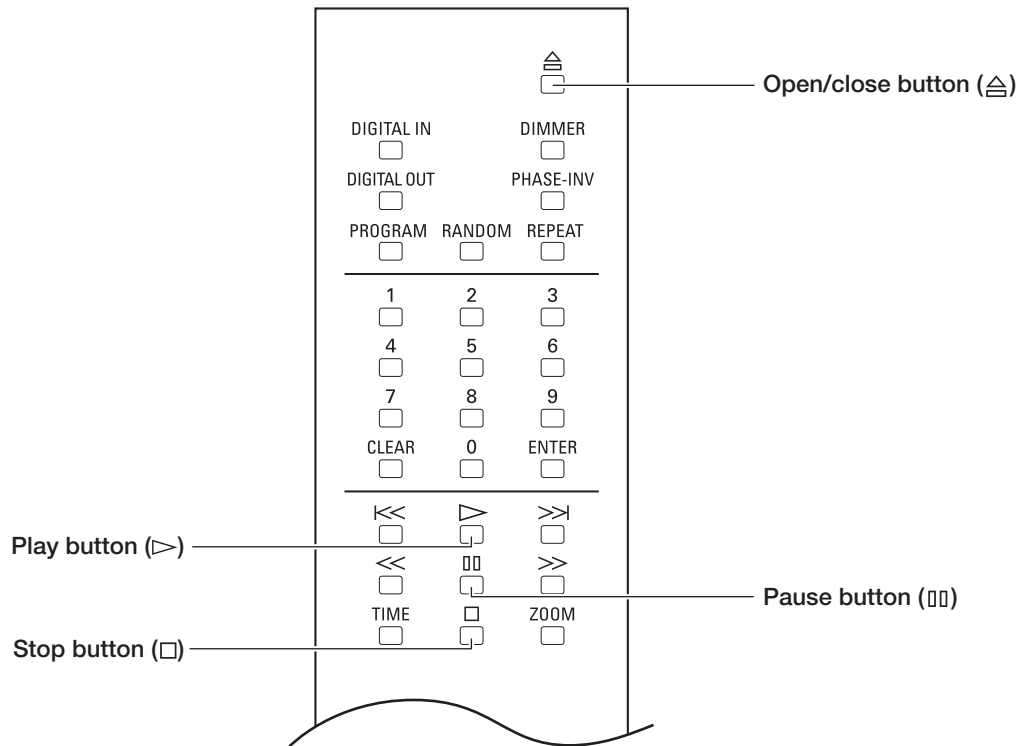

Disc Playback



1. Press the operation button on the main unit to turn it on.

"-OPERATION-" appears on the display for several seconds during the warm-up. When the indication disappears, the unit becomes operable.



2. Press the open/close () button.



The disc tray opens.

3. Put the disc on the disc tray according to the guide on the tray.

4. Press the open/close () button.

The disc tray closes and the disc is loaded.

To start playback quickly, press the play () button without pressing the open/close () button.

Or select a track by pressing a numeric key without pressing the open/close () button, and press the ENTER button or play () button.

Operation buttons and numeric keys are not functional during the period from disc loading to displaying of disc type. Specifying the next operation, for example specifying the number of tracks beforehand, can shorten the time before playback start.

5. Press the play () button.

Pause/stop the playback of the disc.



How to pause playback

1. Press the pause () button.

During pause, the play indicator blinks.

Resumes the regular playback.

2. During pause, press the play () or pause () button.

Stop the playback.

During playback, press the stop () button.

Eject a disc.

Press the open/close () button.

The disc tray opens.

Turn off the power

Press the operation button on the main unit to turn it off.

Skip/Fast-forward/Rewind

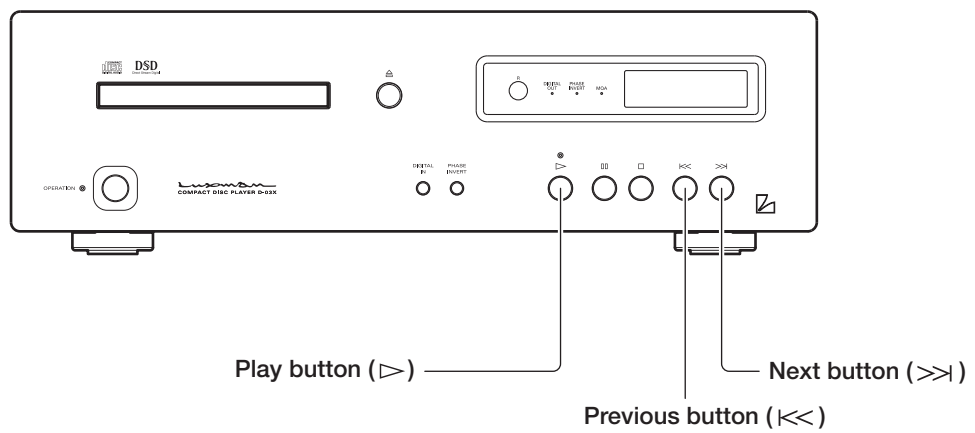
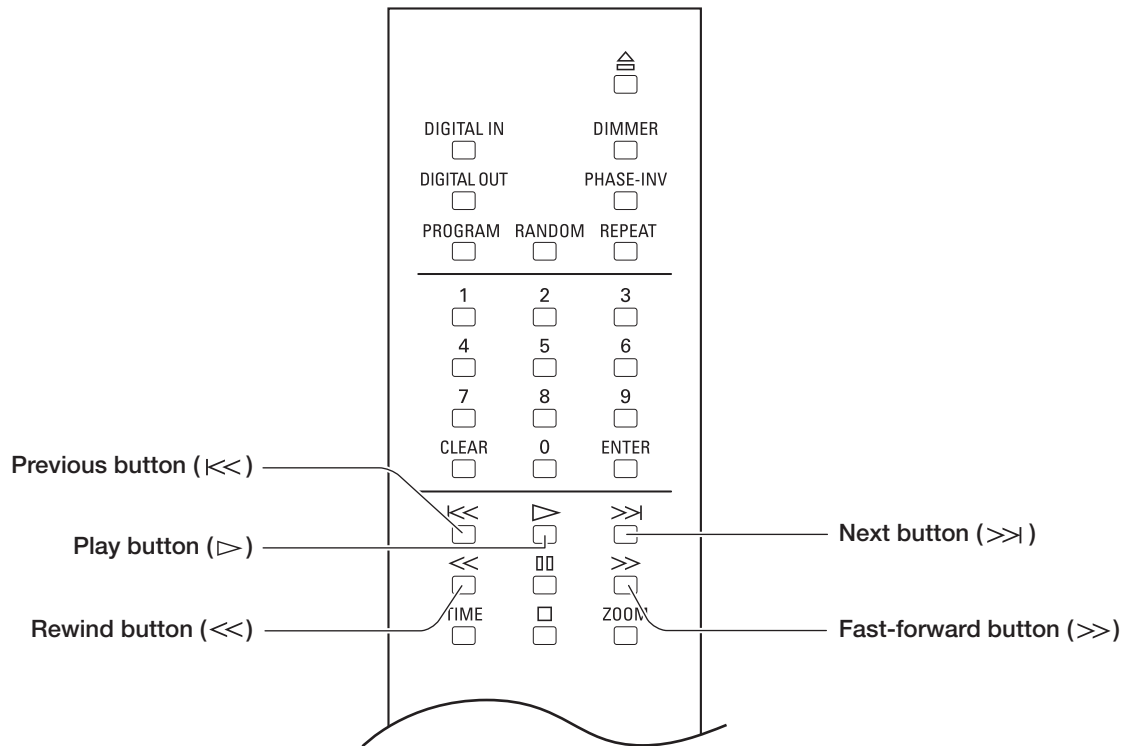

Skipping to a desired track (cue function)



Skip playback Skip to a desired track

To skip to the track to play back, press the next button (>>>) repeatedly until a desired track is displayed.

Go back to a desired track

To go back to the track to play back, press the previous button (<<) repeatedly until a desired track is displayed. When this button is pressed once, the playback returns to the beginning of current track. When this button is pressed twice, playback returns to the beginning of the previous track.

Disc fast-forward/rewind playback (Scan)



Fast-forward the playback.

1. During playback, press the fast-forward (>>) button.

Each time the button is pressed, the rewind speed can be changed in 3 steps.

">>1, >>2, >>3" appears on the display to indicate the fast-forward state and speed.

2. To resume the regular playback, press the play (▷) button.

Rewind the playback.

1. During playback, press the rewind (<<) button.

Each time the button is pressed, the rewind speed can be changed in 3 steps.

"<<1, <<2, <<3" appears on the display to indicate the rewind state and speed.

2. To resume the regular playback, press the play (▷) button

Direct search/repeat playback

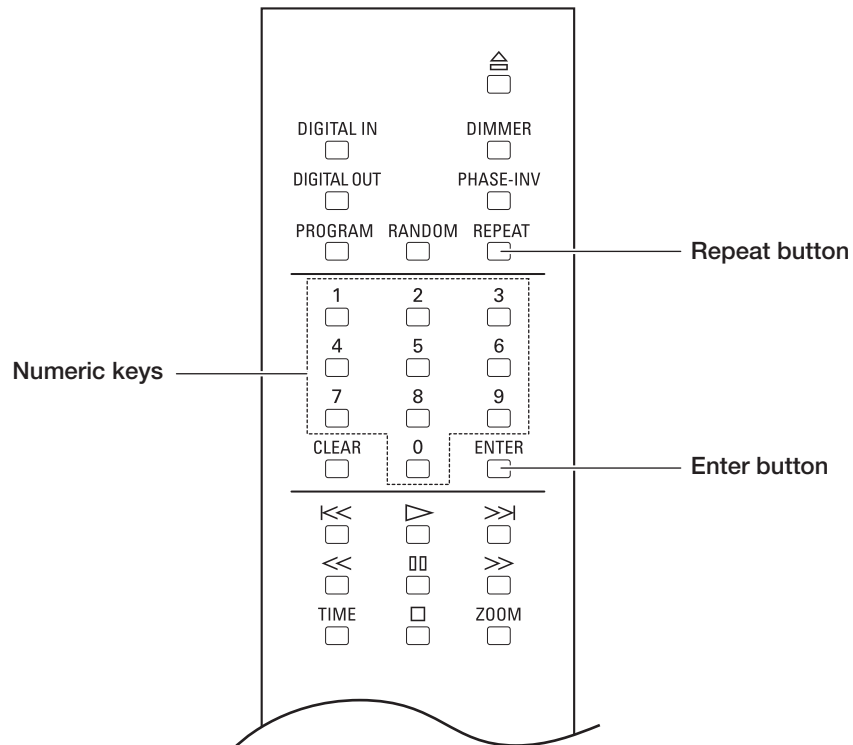

Specify the desired track for playback

Remote control

1. Enter a track number by pressing numeric keys.

For example, when selecting the 15th track, press the “1” key, and then “5”.

2. Press the ENTER or play (▶) button.

Playback is started automatically even without pressing the ENTER button after the elapse of approx. 3 seconds. The maximum number of tracks is 99 for a CD, and it may take longer time to enter a 2-digit track number. For this reason, approx. 3 seconds are given to CDs before auto jump.

Repeat playback

Remote control

There are two types of repeat playback: track repeat (T-REP) and all repeat (A-REP).

Track repeat (T-REP)

1. During playback, press the REPEAT button once.
2. "T-REP" appears on the display to indicate the track repeat.
3. When this button is pressed twice again, the track repeat is canceled.

Repeated playback is also canceled when the disc is stopped.

All repeat (A-REP)

1. During playback, press the REPEAT button twice.
2. "A-REP" appears on the display to indicate the all repeat.
3. When this button is pressed once again, the track repeat is canceled.
Repeated playback is also canceled when the disc is stopped.

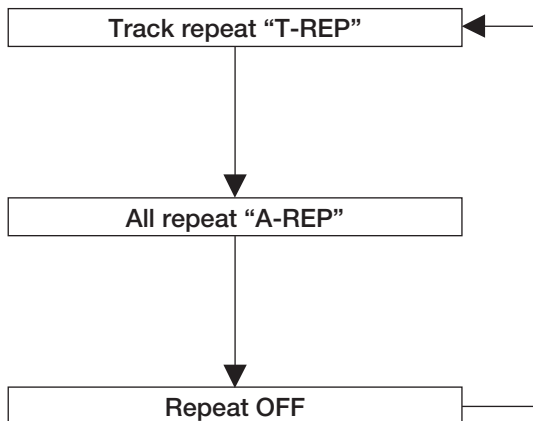

Program Playback

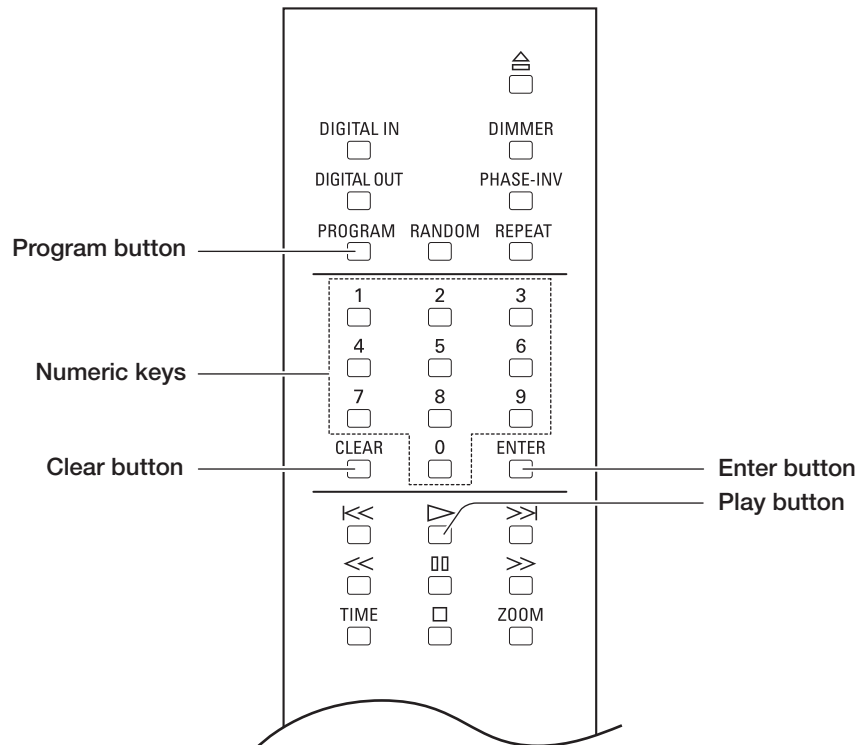

Playback of tracks in a programmed order (Program playback)

Remote control

It is possible to program up to 24 tracks in the desired order.

1. During stop, press the PROGRAM button.

The following indication appears on the display.

```

T-TIME
PG 00 00:00
    
```

2. Enter a desired track number by pressing numeric keys of the remote control.

For example, when selecting the 5th track, press the "5" key.

```

PG 01 5
    
```

3. Press the ENTER button.

The order of the track is determined, and then track number and total time appear on the display.

```

T-TIME
PG 01 01:28
    
```

4. Enter the track number to program next.

For example, when selecting the 15th track, press the “1” key, and then “5”.



5. Press the ENTER button.

The order of the track is determined, and then track number and total time appear on the display.



Program the desired tracks by repeating Step 2 and 3.

6. Press the play (▷) button.



- When pressing the CLEAR button during stop, all the program is deleted.
- When pressing the PROGRAM button, and then the CLEAR button during stop, the tracks will be deleted in the reverse order.
- It is impossible to program pause.
- When pressing the REPEAT button during program playback, programmed all repeat is performed.
- Track repeat is not available during program playback.
- When pressing the next (>>) button during program playback, the playback jumps to the track programmed next.
- To perform the program playback again, press the PROGRAM button during stop, and then the play (▷) button.

Procedure

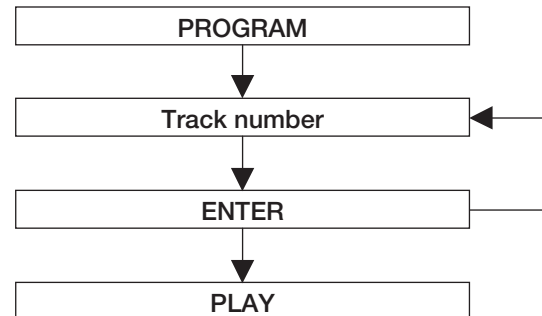

Random playback/disc information/zoom

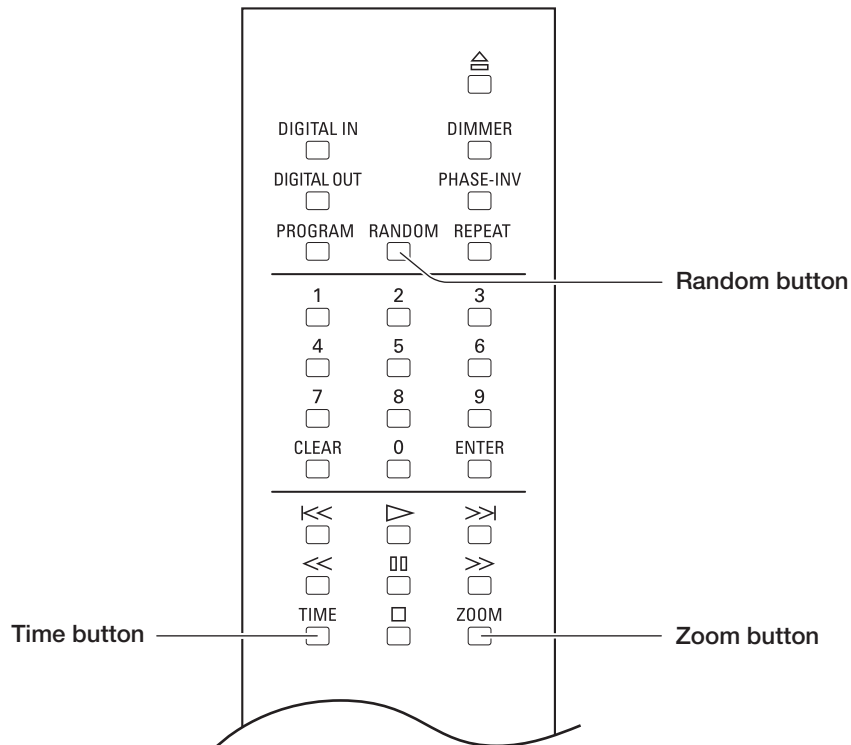

Playback of tracks in a random order (Random playback)

Remote control

Each track is selected from all the tracks and is played back once.

1. Press the RANDOM button.

2. "RD" appears on the display to indicate the random playback. The playback stops automatically after all the tracks are played back.

Random playback stops when a disc is stopped or the RANDOM button is pressed once again. When pressing the next (>>|) button during random playback, the next track is randomly selected and played back. When pressing the previous (|<<) button, the playback returns to the beginning of current track.

Disc information

Remote control

Altering the time display during playback.

Each time the TIME button is pressed during playback, the display changes as follows.

1. The current track number and the elapsed time of the track (In the default setting)

"TRK" will appear on the display.

2. The current track number and the remaining time of the track (Remain)

"TRK" and "REM" will appear on the display.

3. The total remaining time of the disc (Total remain)

"T-REM" will appear on the display window.

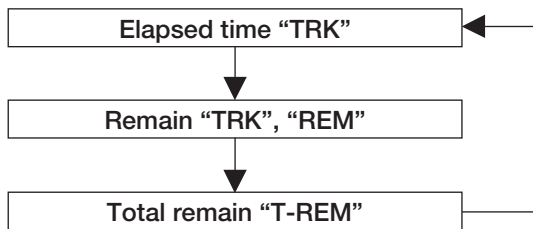

Zoomed display

Remote control

Enlargement of displayed characters

1. Pressing the ZOOM button allows the track number and time to be displayed in a large way.
2. When pressing the ZOOM button once again, the display returns to the normal state.

Normal display

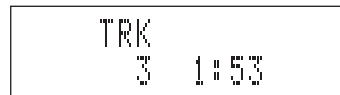

Zoomed display



Detailed Settings

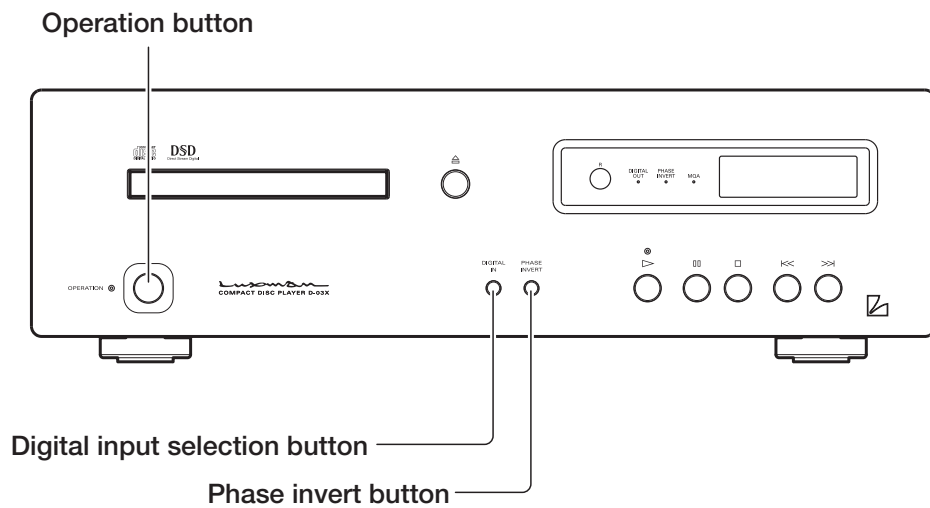
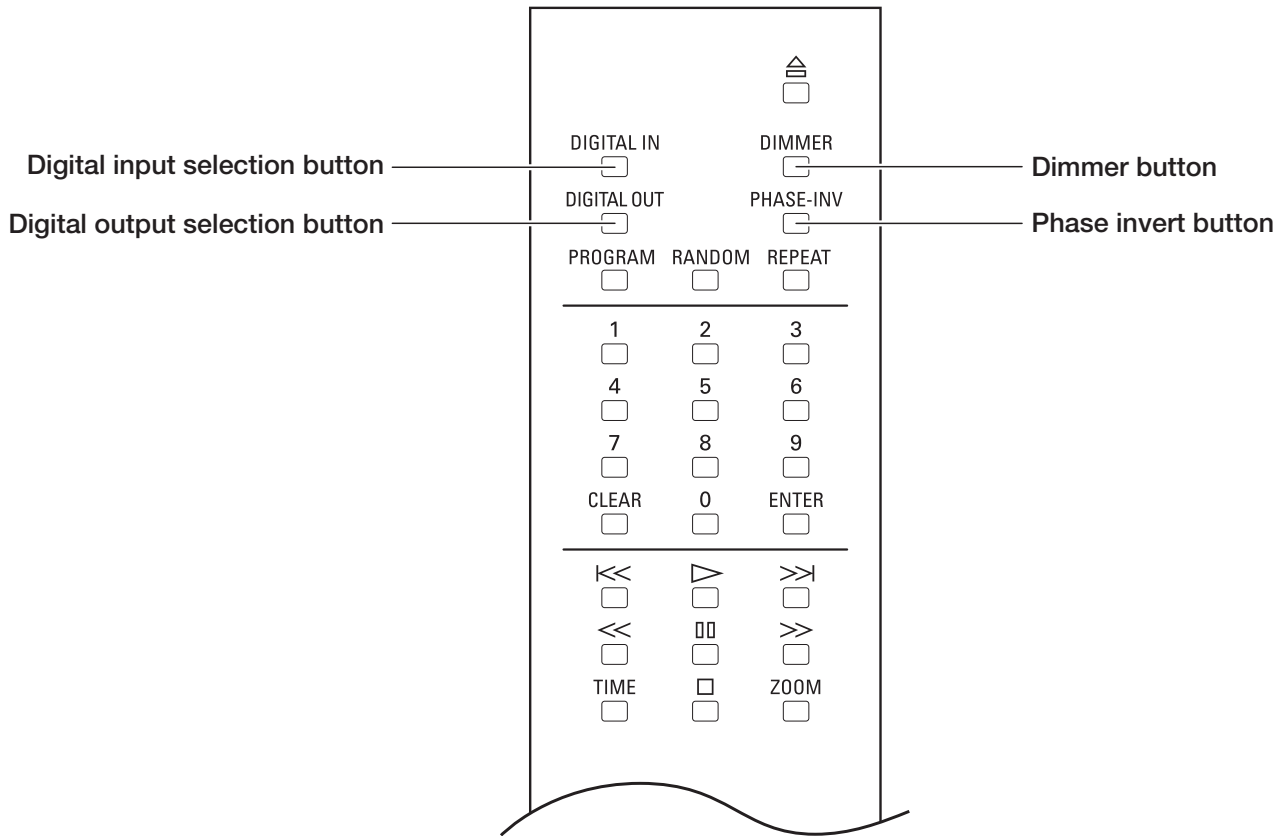

Digital input selection (DIGITAL IN) button



Press this button when using the unit as a D/A converter.

1. Each time the DIGITAL IN button is pressed, the display changes as follows. COAXIAL → OPTICAL → USB → CD

The coaxial and optical inputs are applicable to the following signals.

Sampling frequency : 44.1 kHz, 48 kHz, 88.2 kHz,
96 kHz, 176.4 kHz, 192 kHz
Quantization bit rate : 16-bit, 20-bit, 24-bit

The USB input is applicable to the following signals.

- PCM signal

Sampling frequency : 44.1 kHz, 48 kHz, 88.2 kHz,
96 kHz, 176.4 kHz, 192 kHz,
352.8 kHz, 384 kHz

Quantization bit rate : 16-bit, 24-bit, 32-bit

- DSD signal

Sampling frequency : 2.8 MHz, 5.6 MHz, 11.2 MHz
Quantization bit rate : 1-bit

When using Windows OS, our dedicated driver software needs to be downloaded from the LUXMAN website and installed.

Refer to "Driver Installation Manual" on the LUXMAN website for detailed information.

When using Mac OS, this unit is automatically recognized.

Caution:

Connection between a PC and this unit using a USB cable should not be performed before the installation of the dedicated driver software is completed. Failure to observe this may cause malfunction.

- Each time the DIGITAL IN button on the main unit is held down, the output can be toggled on and off. Each time the button is held down, the output can be toggled on and off.
 - Even if the DIGITAL IN button on the remote control is held down, the digital output cannot be toggled on and off.
-

2. The selected input type and sampling status are displayed on the main unit display window.

This sampling frequency and bit count of the digital signal are displayed, which is connected to the input terminal (COAX/OPT/USB) selected with the digital input selector. When one of COAX/OPTICAL/USB is selected using the digital input selector and the digital signal from each digital device and this unit are synchronized, the sampling frequency and bit count of the digital signal are displayed.

When a digital signal input is not provided or the signal is not synchronized even if the signal input is provided, "UNLOCK" is displayed.

When USB is selected, only the sampling frequency is displayed. The bit count is not displayed.

-
- The bit count (word length) indicates the contents of the word length data included in the channel status which is specified in IEC60958-3 (digital audio interface - Part 3: consumer applications).

Some output devices may provide channel status data (word length data) whose content is different from the actual word length. In such a case, the contents of the channel status data are indicated on the display instead of the actual bit count.

Alternatively, some devices or sources may provide the data that states "the word length is not specified". In such a case, the bit count is not displayed.

- There may be a case where the display indicates "LOCK" shortly, and then "UNLOCK". (The reverse case is also possible.) That is because the former state (LOCK/UNLOCK) is indicated for approx. 0.5 seconds since an input signal is changed until the circuit gets stable.
-

Detailed Settings

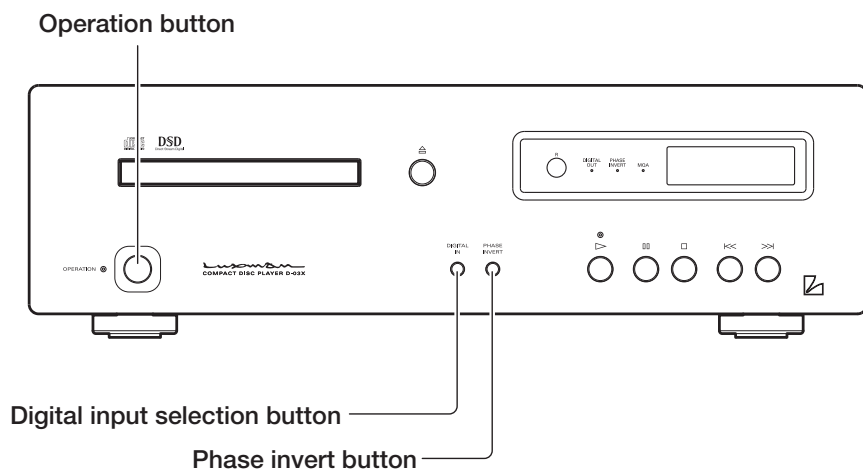
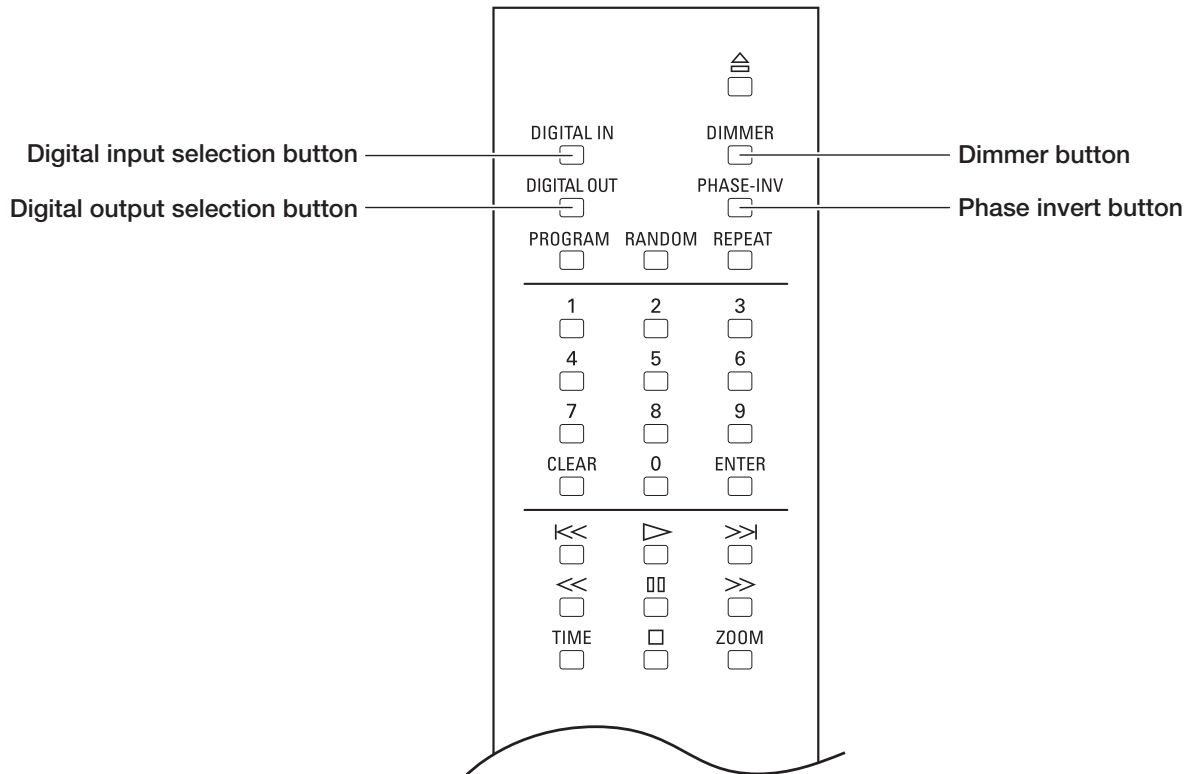

Digital output selection (DIGITAL OUT) button

Remote control

To turn the digital audio output on and off, press the digital output selection button (DIGITAL OUT) on the remote control. Each time the button is pressed, the output can be turned on or off.

- When a PCM or DSD file from a PC is reproduced, this digital audio cannot be outputted. At this time, the DIGITAL OUT indicator turns off.
- When a CD is reproduced, the digital audio output can be turned on and off.
- Each time the DIGITAL IN button on the main unit is held down, the output can be toggled on and off. Each time the button is held down, the output can be toggled on and off.
- Even if the DIGITAL IN button on the remote control is held down, the digital output cannot be toggled on and off.

Phase invert selector (PHASE INVERT/ PHASE-INV) button



• Remote control

The phase of the analog output on the rear panel can be inverted for both the balanced output and unbalanced output.

This setting is stored on the flash memory even when the power is turned off.

Every time this button is pressed, the phase changes as follows: NORMAL→INVERT→NORMAL→INVERT→...

[Phase Normal]

1. GROUND
2. COLD (-)
3. HOT (+)

[Phase Inverted]

1. GROUND
2. HOT (+)
3. COLD (-)

Dimmer button (DIMMER)

Remote control

The brightness of the main unit display can be adjusted. The brightness can be adjusted in 4 steps from light off to normal.

Each time the DIMMER button is pressed, the display changes as follows. Normal light → Dim → Very dim → No light → Normal light → ...

Selection of no light displays "DISPLAY OFF" for 2 second and the sign turns off.

It is impossible to change the brightness of LED.

How to restore all the settings to the factory defaults

All settings can be restored to the factory defaults by the following method

1. Turn off the unit (standby mode).
2. Press the OPERATION button on the main unit while holding down the stop (□) button on the main unit. All the settings will be restored to the factory defaults.

Item	Default
Digital input selection	CD
Digital output selection	On
Phase invert selector	Normal
Dimmer adjustment	Normal
Zoomed display	Normal

Last memory function (Memorization of each setting)

The following table shows the settings which are saved to the flash memory.

If the power is turned off immediately after a setting change, the setting may not be successfully memorized.

Item	Selection
Digital input selection	CD, COAXIAL, OPTICAL, USB
Digital output selection	ON, OFF
Phase invert selector	Normal/invert
Dimmer adjustment	Normal, Dim, Very dim, No light
Zoomed display	Zoomed, Normal

Block Diagram

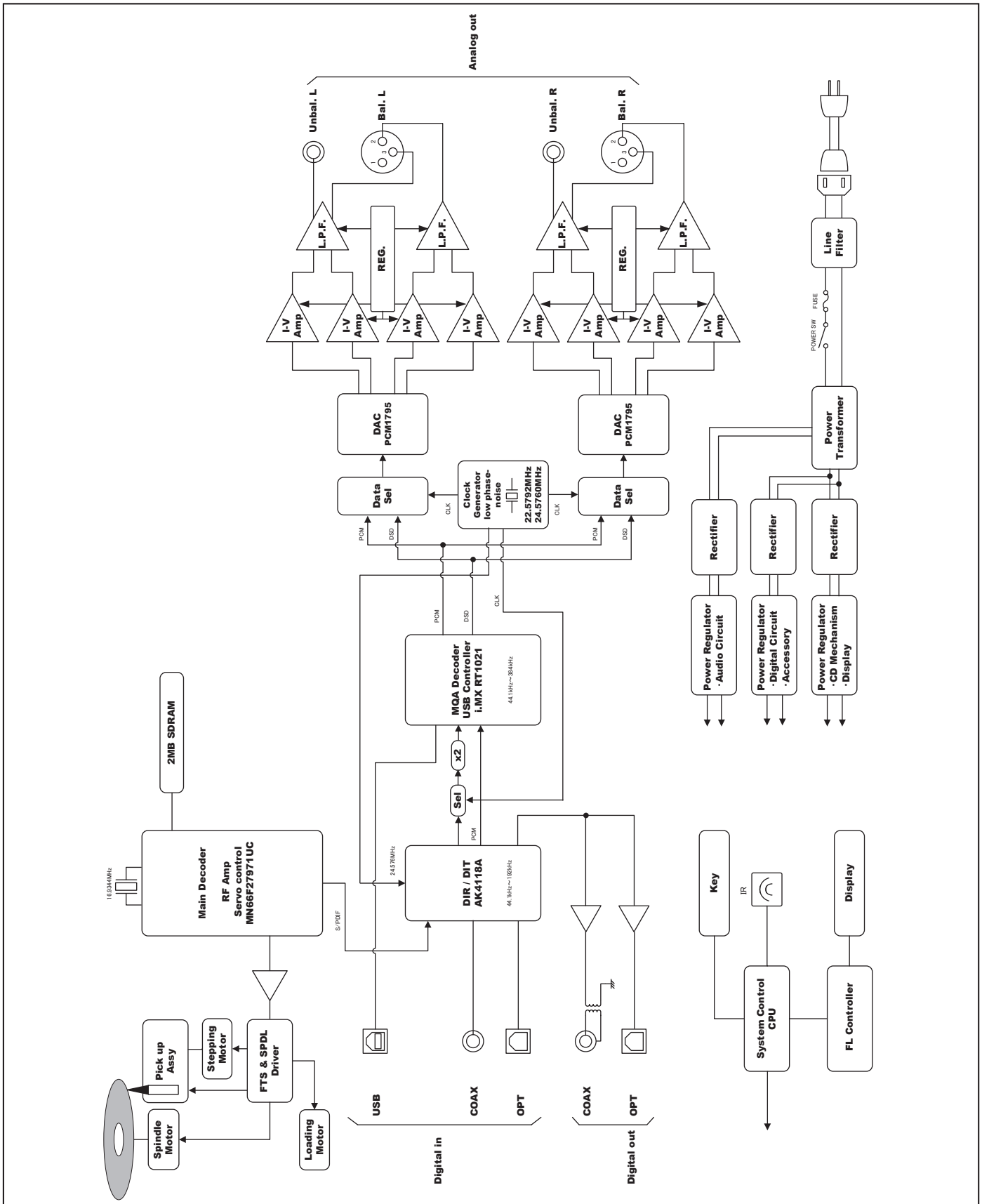

Specifications

luxman
COMPACT DISC PLAYER D-03X

Format	2-channel/CD player		
Power supply	230 V ~ (50 Hz)		
Power consumption	18 W		
Weight	13.2 kg (main unit)		
Max. external dimensions	440 (W) x 133 (H) x 410 (D) mm (front side 2 mm knobs and rear side 18 mm terminals included in depth)		
Ambient operating temperature/ Ambient operating humidity	+5 °C to +35 °C / 5 % to 85 % (non condensing)		
Audio output characteristics	Output voltage/ Output impedance:	LINE	2.4 Vrms/300 Ω
		BAL LINE	2.4 Vrms/600 Ω
		For DSD	1.7 Vrms
	Frequency response:	CD	5 Hz to 20 kHz (+0, -1 dB)
		COAX/OPT	5 Hz to 47 kHz (+0, -3 dB)
		USB	5 Hz to 47 kHz (+0, -3 dB)
	Total harmonic distortion:	CD	0.003 %
		COAX/OPT	0.002 % (96 kHzSF)
		USB	0.002 % (96 kHzSF)
	S/N ratio:	CD	101 dB
		COAX/OPT	114 dB
		USB	113 dB
Dynamic range:	CD	100 dB	
	COAX/OPT	104 dB	
	USB	104 dB	
Channel separation:	CD	102 dB	
	COAX/OPT	121 dB	
	USB	122 dB	
Digital input	Coaxial digital input:	0.2 to 0.6 Vp-p	
	Optical digital input:	-14.5 to -21 dBm	
	USB input: (Applicable OS)	Microsoft Windows 8.1 or later, Mac OS X10.10 or later	
	Sampling frequency:	OPT/COAX:	44.1 kHz, 48 kHz, 88.2 kHz 96 kHz, 176.4 kHz, 192 kHz (16-bit, 20-bit, 24-bit)
		USB input:	44.1 kHz, 48 kHz, 88.2 kHz, 96 kHz 176.4 kHz, 192 kHz, 352.8 kHz, 384 kHz (16-bit, 24-bit, 32-bit) 2.8 MHz, 5.6 MHz, 11.2 MHz (1-bit)
Digital output	Coaxial digital output:	RCA terminal 0.5 Vp-p/75 Ω	
	Optical digital output:	Optical digital terminal -15 to -21 dBm	

* Specifications and appearance are subject to change without notice.

Before Asking for Repair Service

While in use, this unit may display phenomena which may be confused as malfunctions. Before contacting your country's official LUXMAN distributor for repair services, please read the operating instructions for any connected input and output devices and check the troubleshooting table below. If the cause of the malfunction cannot be identified, please contact your dealer. After LUXMAN's representatives have accepted your request for repair services, inspection fees and transportation expenses may be claimed, even though the unit may be found to be operating normally.

Besides, such personal computer as a PC/Mac connected to the unit and the software that operates on the PC/Mac (operations and settings included) are not supported.

Problem	Cause/Solution	Ref. page
No power is supplied even though the operation button is pressed.	<ul style="list-style-type: none"> • Connect the power cable to the AC inlet and the AC outlet firmly. 	18
The disc tray comes out even after the tray is closed.	<ul style="list-style-type: none"> • Set the disc on the disc tray correctly. 	20
	<ul style="list-style-type: none"> • Clean the disc to remove dirt. 	2
Playback cannot be performed.	<ul style="list-style-type: none"> • Clean the disc to remove dirt. 	2
	<ul style="list-style-type: none"> • Set the disc on the disc tray correctly. 	20
	<ul style="list-style-type: none"> • Remove condensation from the interior of this unit. 	1
	<ul style="list-style-type: none"> • Put the disc on the tray with the label facing upwards. (label face upward) 	
No sound is generated. / Sound volume is too low. (Digital input)	<ul style="list-style-type: none"> • Connect digital cables correctly. 	17 - 18
	<ul style="list-style-type: none"> • If the USB is selected as an input source, select this unit (D-03X) as the output destination by configuring the sound setting of a PC/Mac. 	Refer to the instruction manual of the PC/Mac or the software in use.
	<ul style="list-style-type: none"> • If the unit (D-03X) cannot be selected even when trying the solution above, reconnect the USB cable. 	
	<ul style="list-style-type: none"> • If the USB is selected as an input source, adjust the sound volume by configuring the sound setting of a PC/Mac. 	
	<ul style="list-style-type: none"> • If the USB is selected as an input source, adjust the sound volume on a player software of a PC/Mac. 	15 - 16
	<ul style="list-style-type: none"> • Ensure that this unit supports the sampling frequency and the quantization bit rate of the played back digital signals. 	
The remote control cannot be operated.	<ul style="list-style-type: none"> • Check to see whether "UNLOCK" of the digital input is displayed or not. (When the digital signal from the digital device is not synchronized with this unit, the source may not be played back.) 	
	<ul style="list-style-type: none"> • Operate the remote control within the specified operating range. 	7
	<ul style="list-style-type: none"> • Replace the remote control battery with a new one. 	6
An electronic device such as a television malfunctions.	<ul style="list-style-type: none"> • The remote control infrared receiver is exposed to direct sunlight or strong light sources (such as inverter fluorescent lights). Change the installation place or angle to avoid the exposure to light sources. 	7
	<ul style="list-style-type: none"> • Some devices equipped with a wireless remote control receiver may malfunction when the remote control of this unit is operated. Keep this unit away from such devices. 	7

Problem	Cause/Solution	Ref. page
No sound is generated from the speakers, or sound is distorted.	• Confirm that the connections of audio cables are correct.	17 - 18
	• Clean the disc to remove dirt.	2
	• When the output level of an amplifier, etc. is minimum, adjust the volume.	
	• Confirm that the cable connectors are connected and firmly inserted into the terminals of the unit.	
Digital audio signals cannot be output digitally.	• Clean the cable connectors and terminals by using a plain dry cloth or a cloth dipped in a small amount of dehydrated alcohol.	
	• When a PCM or DSD file from a PC is reproduced, a digital audio output cannot be outputted.	

This unit may not work normally when the unit is subject to external influence such as static electricity. In such a case, normal operation may resume by turning off the power once and turning on the power again after several tens of seconds or returning the unit to the factory setting. If the problem is not solved, please contact your dealer or our service center.

MEMO

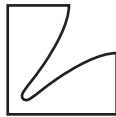

LUXMAN CORPORATION, JAPAN

1-3-1 Shinyokohama, Kouhoku-ku, Yokohama-shi, Kanagawa 222-0033, Japan

AG00987E91A
Printed in Japan