

The Luxman logo is rendered in a white, elegant, cursive script font against a dark grey rectangular background. The letters are closely spaced and have a fluid, handwritten quality.

USB D/A CONVERTER

DA-06

Owner's Manual

Contents

Precautions	1
Features Of This Unit	2
Names and Functions.....	4
Connections	10
Operations.....	13
Block Diagram.....	14
Specifications	15
Before Asking for Repair.....	16

Precautions

USB D/A CONVERTER DA-06

Installation place

- Choose a stable place near the devices that are to be used in combination with this unit.
- Do not install this unit near a television or color monitor. Keep this unit away from such devices as cassette decks that are subject to magnetism.

Avoid the following locations for installation.

- Locations exposed to direct sunlight
- Places subject to humidity and with less ventilation
- Places where are extremely hot or cold
- Places subject to strong vibration
- Places subject to dust
- Places subject to oil, steam, and heat (such as kitchens)

To avoid heat emission

Do not place this unit on such device as an amplifier that may emit heat. If the unit is installed on a rack, install the unit as distantly as possible from where the amplifier is installed so as to avoid heat emission from the amplifier and other audio devices.

Power off this unit when it is not used.

Depending on the condition of radio waves emitted during television broadcasting, interference fringes may appear on the television monitor, but that is not a malfunction. In such a case, power off the unit. There may also be a case where noises are heard on the radio due to radio wave interference.

Notice when handling optical digital cables

- Do not fold the cables. For storage, wind each cable to make a coil whose diameter is approx. 15 cm or larger.
- For connection, insert the cable connectors firmly into the terminals of this unit and the other device.
- Use the cables whose each length is 3 m or less.
- When the cable connectors get dusty, wipe the dust away with a dry soft cloth before inserting into the terminals.

Cleaning

- Usually, wipe the unit with a dry soft cloth.
When the dirt is hard to remove, dip soft cloth in detergent diluted 5 or 6 times with water, wring it well, and remove contaminants. Then, remove the moisture with dry cloth.
- Do not use a solvent like alcohol, benzine, thinner, or pesticide because such a substance can damage the exterior. In addition, do not let this unit contact a rubber or plastic form for a long time. That may damage the cabinet surface of the unit.
- When using a chemical cloth for cleaning, read the caution provided with the chemical cloth product.
- Before cleaning, unplug the power cord from the AC outlet.

Precautions in connecting with other components

When connecting this unit with an I/O equipment other than PC/Mac such as CD player and DVD player, be sure to turn off the power switches of this unit and all other connected units. Failure to observe this may generate a strong noise resulting in speaker damage or cause a malfunction.

The pin-plug to be inserted in each input terminal of this unit shall be pushed in firmly. If the grounding terminal is inadequately connected, noises including hum may be generated, resulting in an adverse S/N ratio.

Repair and adjustment

When repairs or adjustments are needed, please ask the dealer where you bought the unit.

Features Of This Unit

New standard size

We have adopted LUXMAN's standard width of 440 mm, and have developed a highly rigid chassis with new size of 80 mm in height.

USB input that is applicable to 384kHz / 32 bit

Introduction of a B-type USB input terminal that allows the input of USB digital audio signal from a PC/Mac.

The sampling frequency of up to 384 kHz and 32-bit quantization are applicable.

USB input DSD supported

DSD format data can be entered from PC/Mac, or the like.

Sampling frequencies of 2.822MHz/5.644MHz is applicable.

Circuits whose grade is equivalent to D-06

High-performance circuits, equivalent to those of the SACD player D-06, are used for the peripheral circuit of DAC and the analog output amplifier.

DD converter function

Input of 192 kHz 24 bit or less including USB input can be digitally provided in the S/PDIF format.

Analog circuit

Amplifier circuit with improved sound quality drives the outputs from the D/A converters.

Balance output

This unit is equipped with an XLR balance output terminal with full-fledged balanced- structure circuit.

Analog output phase switching

Both balanced output and unbalanced output are phase switchable.

32 bit digital filter

Thanks to the dedicated digital filter with 32 bit arithmetic processing, inputs of 44.1 kHz/88.2 kHz/176.4 kHz are upsampled to 352.8 kHz and inputs of 48 kHz/96 kHz/192 kHz are upsampled to 384 kHz.

For PCM data, 3 types of digital filters are switchable, and for DSD data, 2 types of analog FIR filters are switchable.

PCM1792A manufactured by Burr-Brown

For the DAC chip, this unit uses PCM1792A manufactured by Burr-Brown that has been used for the Luxman SACD players D-series with the right and left independent monaural configuration.

Low phase noise crystal oscillator

This unit uses an oscillator with low noise near the oscillating frequency.

This oscillator provides clocks with less jitter.

Asynchronous communication supported

The USB input with low jitter has been achieved with USB dedicated DSP by asynchronous communication and PLL.

7-segment LED

Placement of a 3-digit 7-segment LED with a high level of visibility in a double-deck manner has been introduced.

The sampling frequency and bit count of a digital input are displayed on the monitor. (bit count displayed only at S/PDIF input)

Dimmer function

The brightness of display can be switched over in 4 steps.

Analog output terminals

Introduction of an 18 mm pitch RCA terminal with gold plating and a high-grade XLR terminal manufactured by Neutrik allows even a line cable with large plug to be connected.

Digital input terminals

This unit is equipped with 2 coaxial terminals, 2 optical terminals, and 1 balance terminal.

This unit is compatible with S/PDIF format signals between 32 kHz and 192kHz.

It is possible to play back the digital audio signal that is output from another audio device via the circuit of the unit that improves the sound quality.

Digital inputs (S/PDIF) with low jitter has been achieved with PCM9211 PLL manufactured by Burr-Brown.

Last memory function

The setting data of digital filter, analog output polarity, and the like is stored on the flash memory.

Digital output OFF

The digital audio output can be deactivated to improve the quality of analog audio output.

High rigid leg

This unit uses aluminum machining high rigid legs.

High-inertia power supply

This unit uses high-inertia power supply circuit that is combined of OI core type power transformer and customizable 10,000 μ F \times 2 capacitor blocks.

Introduction of original technologies

Our traditional round pattern board, OFC internal wiring, and original custom-made parts are fully and luxuriously introduced.

*1 Mac and Mac OS are trademarks of Apple Inc., registered in the U.S. and other countries.

*2 Windows is a registered trademark of Microsoft Corporation in the United States and/or other countries.

*3 DSD is a trademark.

*4 The described company names and product names are trademarks or registered trademarks of each company.

Names and Functions

Front panel

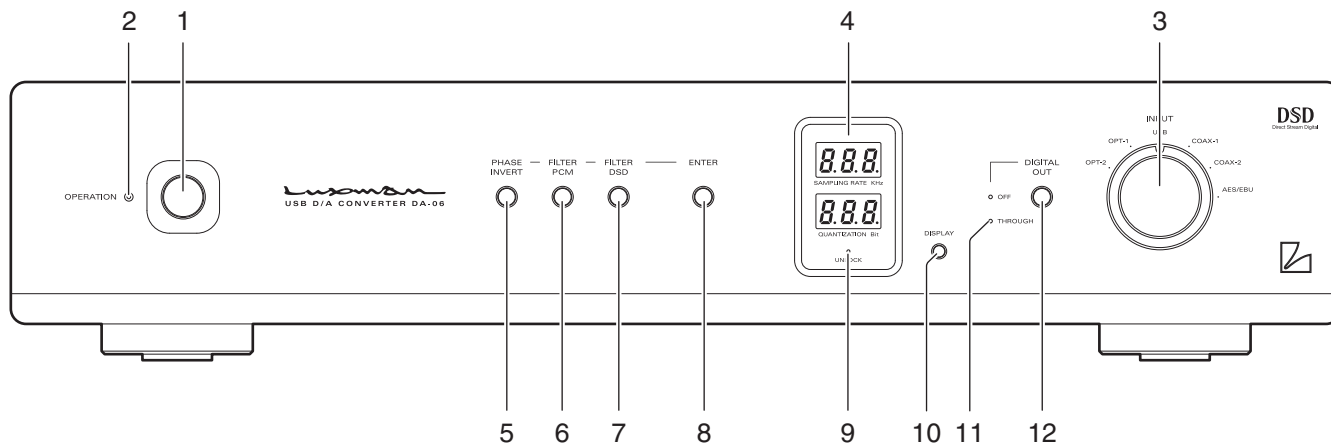

1. Operation switch (OPERATION)

Toggles the power on and off.

When wiring or connection is performed, be sure to turn off this switch.

2. Operation indicator (OPERATION)

Blinks in the time of muting mode when the operation switch is turned on and lights up when the operation state is activated afterward.

3. Input selector (INPUT)

Selects an input device connected to each input terminal. The input selector has 6 positions consisting of OPT-2, OPT-1, USB, COAX-1, COAX-2, and AES/EBU from left to right that correspond to each input terminal on the rear panel. To select an input source, set the pointer of the selector to the position of the source to be reproduced.

4. Sampling frequency LED (SAMPLING RATE), bit count display LED (QUANTIZATION Bit)

This LED displays the sampling frequency and bit count of the digital signal connected to the input terminal (OPT/USB/COAX/AES/EBU) selected with input selector. When a digital input is selected from OPT/USB/COAX/AES/EBU with the input selector and the digital input signal from the digital device is synchronized with this unit, the sampling frequency and bit count of the digital signal are displayed on this LED.

When no digital signal is input or no synchronization is established even with a digital signal input, the digital signal unlock indicator lights up, and the sampling frequency is not displayed on the LED.

When USB is selected, only the sampling frequency is displayed. The bit count is not displayed.

When reproduction from a PC/Mac is stopped, the sampling frequency disappears and the unlock indicator stays off. This phenomenon indicates that communication with the PC/Mac stays active.

The following sampling frequencies can be displayed.

At signal input to USB terminal:

32 kHz, 44.1 kHz, 48 kHz, 88.2 kHz, 96 kHz, 176.4 kHz,
192 kHz, 352.8 kHz, 384 kHz

At signal input to OPT/COAX/AES/EBU terminals:

32 kHz, 44.1 kHz, 48 kHz, 88.2 kHz, 96 kHz, 176.4 kHz,
192 kHz

First 3 digits are displayed on the LED.

At the signal input to the OPT/COAX/AES/EBU terminals, the bit count is displayed when the beginning of music is reproduced. When reproduction starts from the middle of music, "----" is displayed for bit count.

5. Analog output phase selection switch (PHASE INVERT)

The phase of the analog output on the rear panel is inverted.

Both the balanced output and line output are inverted.

Pressing this switch displays the current setting data (3-P, 2-P) on the display LED.

Pressing this switch again while the setting data is displayed displays the next setting data.

Pressing the enter switch (ENTER) while the setting data is displayed determines the setting data.

If the enter switch is not pressed, the setting data is not changed.

This setting is stored on the flash memory even when the power is turned off.

[Normal Position]

PH Indicates that the 3-Pin of the balanced
3-P output is positive.

Indicates that the 3-Pin of the balanced output is positive.

[Invert Position]

PH Indicates that the 2-Pin of the balanced
2-P output is positive.

6. Digital filter selection switch (FILTER PCM)

This switch changes the interpolation function of the 32 bit digital filter while the PCM data is reproduced.

You can hear a change in sound quality, and therefore, select a filter depending on your taste. There are 3 types of filters, P-1, P-2, and P-3. Pressing this switch displays the current setting data (P-1, P-2, P-3) on the display LED. Pressing this switch again while the setting data is displayed displays the next setting data. Pressing the enter switch (ENTER) while the setting data is displayed determines the setting data. If the enter switch is not pressed, the digital filter is not changed. The impulse response of the interpolation function shows the waveform below.

This setting is stored on the flash memory even when the power is turned off.

P-1 (normal FIR filter)

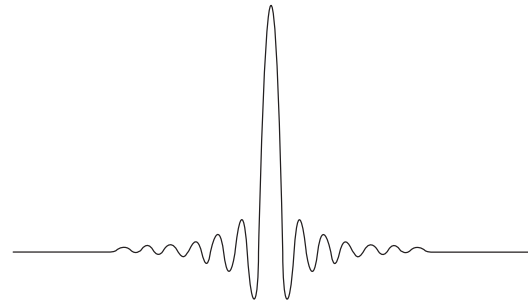

P-2 (low latency IIR filter)

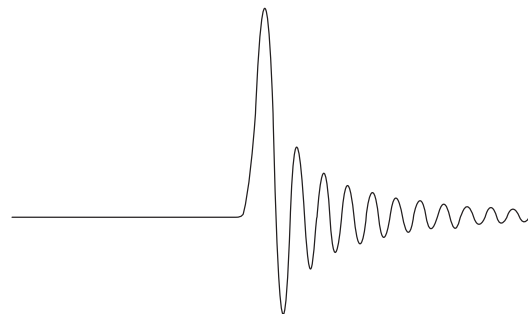

P-3 (high attenuation FIR filter)

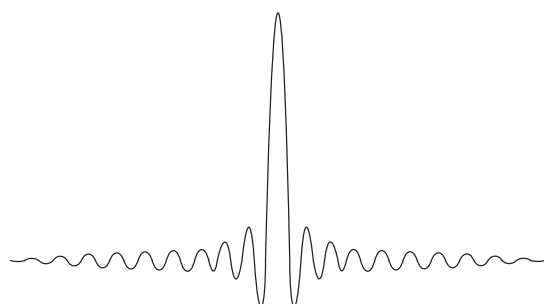

Names and Functions

Front panel

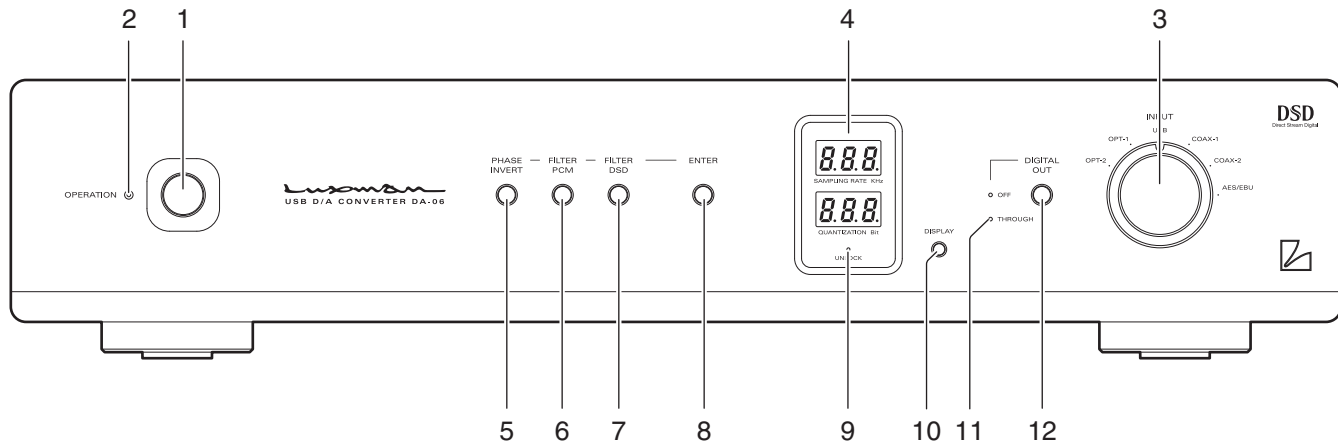

7. Analog FIR filter selection switch (FILTER DSD)

This switch changes the analog FIR filter while the DSD file is reproduced.

You can hear a change in sound quality, and therefore, select a filter depending on your taste.

There are 2 types of filters, d-1 and d-2.

Pressing this switch displays the current setting data (d-1, d-2) on the display LED.

Pressing this switch again while the setting data is displayed displays the next setting data.

Pressing the enter switch (ENTER) while the setting data is displayed determines the setting data.

If the enter switch is not pressed, the filter is not changed.

The analog FIR filter features the following:

d-1 (normal analog FIR filter)

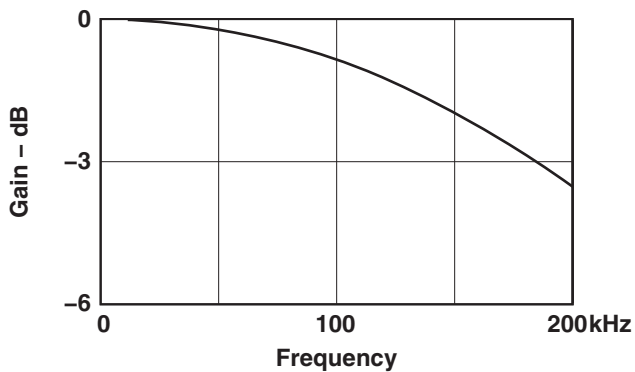

d-2 (high attenuation analog FIR filter)

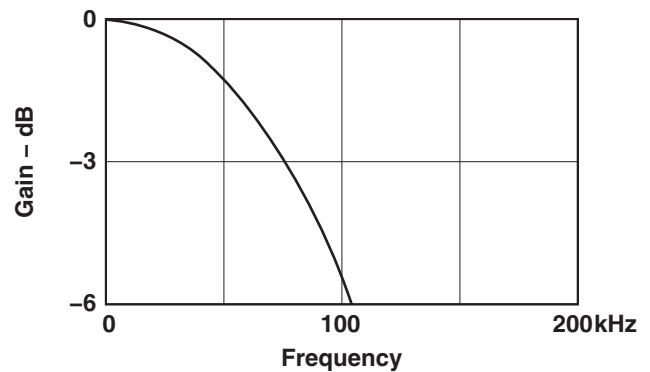

8. Enter switch (ENTER)

This switch determines the setting data of analog output phase switching (PHASE INVERT), digital filter selection (FILTER PCM), analog FIR filter selection (FILTER DSD), and display switching (DISPLAY).

9. Digital signal unlock indicator (UNLOCK)

This indicator lights up when this unit is not synchronized with the digital device connected to the input terminal selected with the input selector.

10. Display switch (DISPLAY)

This switch adjusts the brightness of the LED displays of the sampling frequency and bit count.

Pressing this switch displays the current brightness.

Pressing this switch again while the current brightness is displayed changes the brightness as follows:

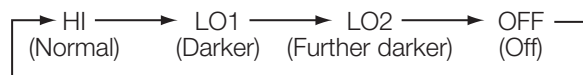

Selection of OFF displays "OFF" for a few seconds and the display goes out.

This setting is stored on the flash memory even when the power is turned off.

11. Digital output display LED (OFF/THROUGH)

This LED displays the status of digital audio output.

When the output is off, "OFF" lights up, and when the output is on, "THROUGH" lights up.

When "THROUGH" lights up, the input signal selected with the input selector is provided to the digital output terminal. Upsampling is not performed.

When a DSD file is reproduced, a digital audio output cannot be provided.

12. Digital output selection switch (DIGITAL OUT)

This switch is pressed for making a digital audio output off or through.

Pressing this switch toggles between off and through.

This setting is stored on the flash memory even when the power is turned off.

When a DSD file is reproduced, a digital audio output cannot be provided.

When the PCM data of 32 kHz, 352.8 kHz, or 384 kHz sampling frequency is reproduced, a digital audio output cannot be provided.

Names and Functions

Rear panel

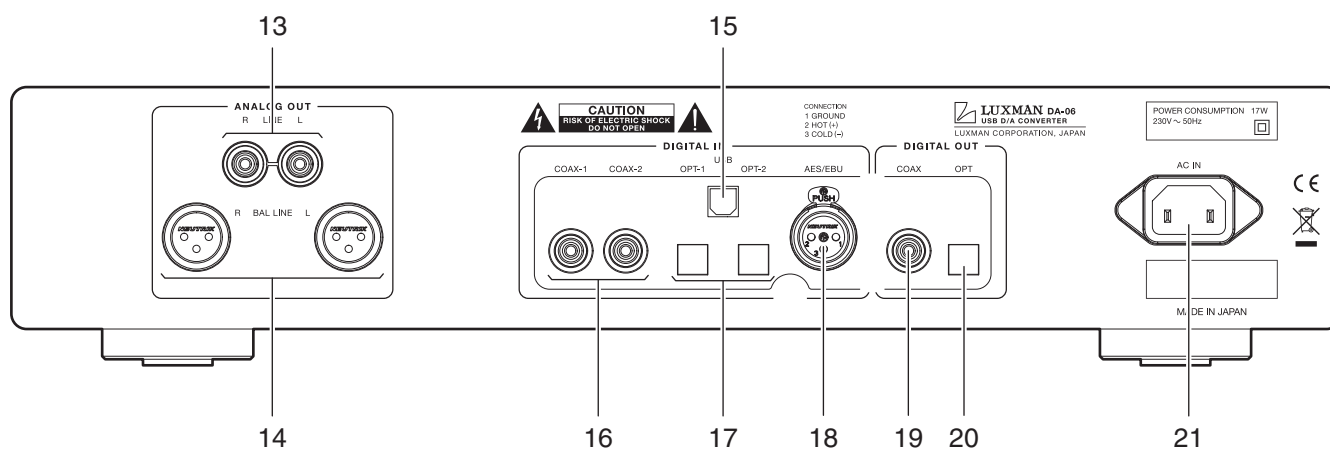

13. Analog unbalance output terminals (LINE)

These are RCA output terminals used for the unbalanced playback output signals from this unit.

Connect these terminals to an unbalanced input of such device as a pre-amplifier with a pin cable.

The phase can be switched with the analog output phase selection switch (PHASE INVERT) on the front panel.

[Normal Position]

Setting as [PH 3-P]

[Invert Position]

Setting as [PH 2-P]

14. Analog balance output terminals (BAL LINE)

These are XLR output terminals used for the balanced playback output signals from this unit.

Connect these terminals to a balanced input of an output device such device as a pre-amplifier with a balanced cable.

The following are the phases of the output terminals of this unit:

[Normal Position]

1. GROUND
 2. COLD (-)
 3. HOT (+)
- (PH 3-P) setting

[Invert Position]

1. GROUND
 2. HOT (+)
 3. COLD (-)
- (PH 2-P) setting

15. Digital input terminal (USB)

This is a USB (B-type) input terminal used for the digital input signal from such device as a PC/Mac using a USB cable.

The terminal is applicable to the following data.

- PCM signal

Sampling frequency : 32 kHz, 44.1 kHz, 48 kHz, 88.2kHz, 96kHz, 176.4kHz, 192kHz, 352.8kHz, 384kHz

Number of quantization bits : 6bit, 24bit, 32bit

- DSD signal

Sampling frequency : 2.8224MHz, 5.6448MHz

Number of quantization bits : 1bit

When the OS is Windows, the dedicated driver software needs to be installed.

Read the separate software installation manual.

16. Digital input terminal (COAX)

This is an RCA input terminal used for the digital input signal from such device as a CD player equipped with digital output terminals using a coaxial digital cable.

The terminal is applicable to the following data.

Sampling frequency : 32kHz, 44.1kHz, 48kHz, 88.2kHz, 96kHz, 176.4kHz, 192kHz

Number of quantization bits : 16bit, 20bit, 24bit

17. Digital input terminal (OPT)

This is a TOS-LINK input terminal used for the digital input signal from such device as a CD player equipped with digital output terminals using an optical digital cable.

The terminal is applicable to the following data.

Sampling frequency : 32kHz, 44.1kHz, 48kHz,
88.2kHz, 96kHz, 176.4kHz,
192kHz

Number of quantization bits : 16bit, 20bit, 24bit

18. Digital input terminal (AES/EBU)

This is an XLR input terminal used for the digital input signal from such device as a CD player equipped with digital output terminals using an balanced digital cable.

Sampling frequency : 32kHz, 44.1kHz, 48kHz,
88.2kHz, 96kHz, 176.4kHz,
192kHz

Number of quantization bits : 16bit, 20bit, 24bit

19. Digital output terminal (COAX)

This is an RCA output terminal used to output the digital signal that has been input from the digital input terminal (OPT/USB/COAX/AES/EBU).

The digital input signal selected by rotating the input selector is output. The sampling frequency and the number of quantization bits of the digital output signal are the same as those of the input signal.

No signal output is provided when a DSD file is reproduced. When the PCM data of 32 kHz, 352.8 kHz, or 384 kHz sampling frequency is reproduced, a digital audio output cannot be provided.

20. Digital output terminal (OPT)

This is a TOS-LINK output terminal used to output the digital signal that has been input from the digital input terminal (OPT/USB/COAX/AES/EBU).

The digital input signal selected by rotating the input selector is output.

No signal output is provided when a DSD file is reproduced.

When the PCM data of 32 kHz, 352.8 kHz, or 384 kHz sampling frequency is reproduced, a digital audio output cannot be provided.

21. AC inlet (AC IN)

Connects the accessory power cable. The power should be obtained from a 230 V AC outlet.

Connections

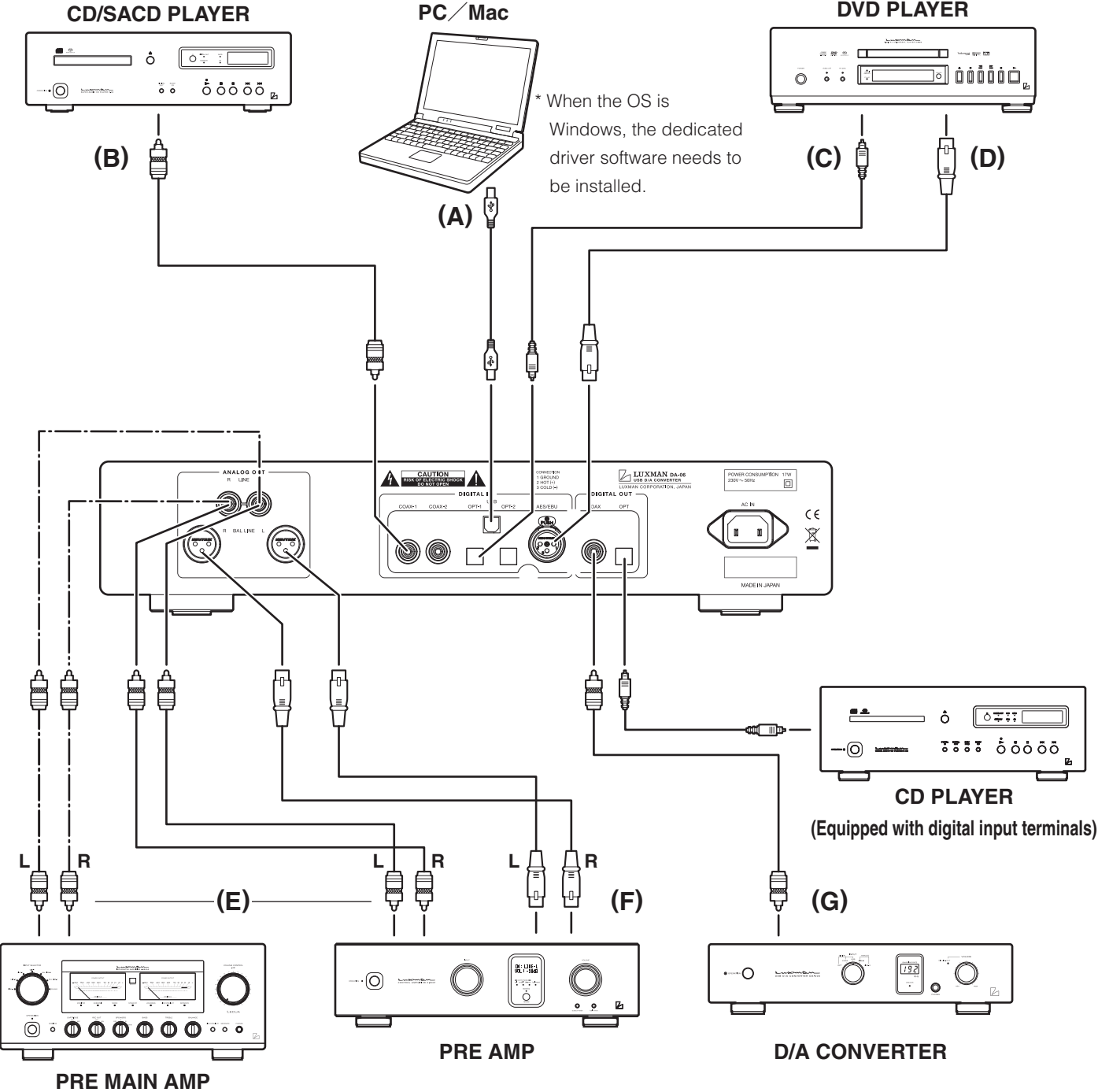

Before Connecting

Before connecting other devices, connect the jack side (where three holes are provided) of the accessory power cable to the AC inlet of this unit.

When connecting, turn off the power supply of this unit and the power supplies of auxiliary devices to prevent unexpected accidents that may be caused by noise.

How to connect power supply

Use the accessory power cable and insert the AC plug in an outlet on the wall in the room where the unit will be installed.

Connections

How to connect input devices

1. Digital connection from a PC/Mac (Refer to "A" in the connection diagram.)

Connect between the USB terminal (A-type) of the PC/Mac and the USB terminal (B-type) of this unit with a USB cable. When the OS is Windows, this unit is not automatically recognized. The dedicated driver software needs to be installed. Read the separate software installation manual. With Mac, this unit is automatically recognized.

2. Digital connection from such device as a CD player (Refer to "B", "C" and "D" in the connection diagram.)

Connect between the (coaxial, optical, and balanced) digital output terminal of a CD player, an SACD player, a DVD player, and other such devices and the digital input terminal (COAX/OPT/AES/EBU) of this unit with a coaxial digital cable, an optical digital cable, and a balanced digital cable.

This terminal has a shutter. Direct the cable connector correctly when inserting the cable into the terminal. If the cable connector is inserted forcibly with the wrong direction, the terminal may be deformed, and the shutter may not be able to close even after cable disconnection.

Upper side

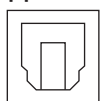

Lower side

The optical terminals are directed as illustrated.

How to connect output devices

1. Unbalanced connection with such device as a pre-main amplifier (Refer to the connection diagram (E).)

Connect between the analog unbalance output terminals (LINE) of this unit and the unbalance input terminals of such device as a pre-main amplifier with 2 (R and L) RCA pin-plug cables.

2. Balanced connection with such device as a pre-amplifier (Refer to "F" in the connection diagram.)

Connect between the analog balance output terminals (BAL LINE) of this unit and the balance input terminals of such device as a pre-main amplifier with 2 (R and L) XLR balanced cables.

3. Digital output to such device as another D/A converter (Refer to "G" in the connection diagram.)

Connect between digital output terminal (COAX/OPT) of this unit and such devices as a D/A converter and a CD player equipped with digital input terminals with a coaxial digital cable or an optical digital cable.

This unit is a D/A converter. Any operations for sound reproduction are performed with such input device as a PC/Mac or CD player connected to the input terminals.

Before operation

1. Ensure that the connections are correctly performed.
(Normal playback cannot be achieved with wrong connections of R and L.)
2. Press the operation switch to turn on the power.

Sound reproduction of a device connected to a digital input terminal (Analog output)

1. Select an input device to be reproduced with the input selector. (OPT/USB/COAX/AES/EBU)
2. When the input devices starts reproduction, the digital signal unlock indicator (UNLOCK) turns off, and the sampling frequency of the playback signal is displayed on the LED.

If the digital signal is not normally input to the unit, the digital signal unlock indicator (UNLOCK) lights up, and signal is not output.

3. When the analog unbalanced output terminal (LINE) is connected to such devices as a pre-main amplifier or when the analog balanced output terminal (BAL LINE) is connected to such devices as pre-amplifier, adjust the audio volume with the volume control of the output device.

How to use the digital output

The playback signal that is input from a digital device to this unit can be output from a digital output terminal to such devices as another D/A converter and a CD player equipped with digital input terminals.

(A CD player equipped with no USB input terminals can receive digital signal that is input from the USB input terminal of this unit by connecting between a digital input terminal (OPT/COAX) of the player and a digital output terminal (OPT/COAX) of the unit.)

1. Select an input device to be reproduced with the input selector. (OPT/USB/COAX/AES/EBU)
2. Adjust the sound volume with the volume control of the connected system device.

Block Diagram

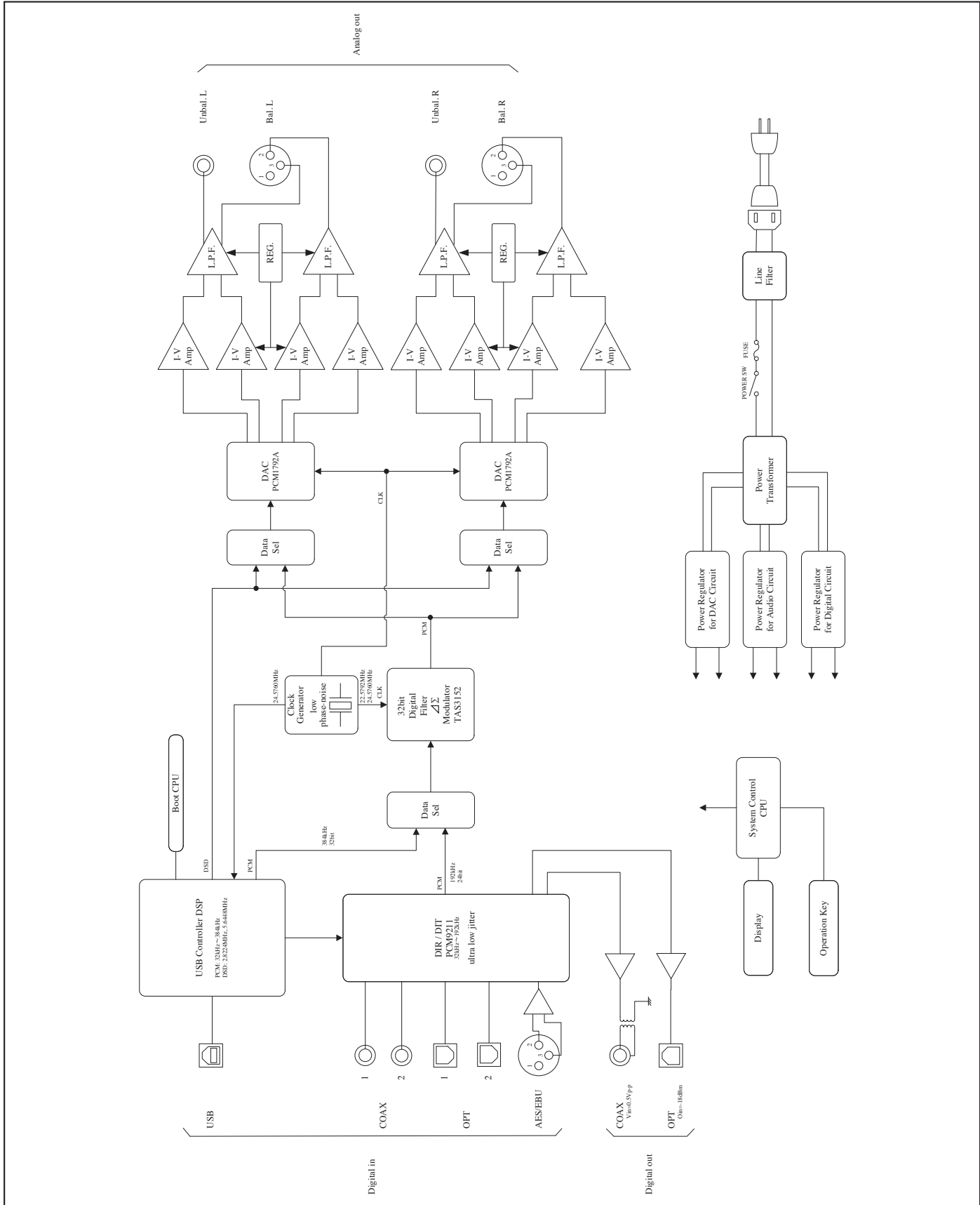

Specifications



Format	2-channel, USB D/A converter	
Ambient operating temperature	+5 °C to +35 °C	
Audio output characteristics	Output voltage / output impedance:	UNBALANCE terminal (RCA terminal) 2.5 Vrms/300Ω BALANCE terminal (XLR terminal) 2.5 Vrms/600Ω
	Frequency response:	4 Hz to 20 kHz (+0, -0.4 dB) 2 Hz to 55 kHz (+0, -3.0 dB)
	Total harmonic distortion:	0.0005 % / Unbalanced 0.0005 % / Balanced
	S/N ratio:	124 dB
	Dynamic range:	120 dB
	Channel separation:	120 dB
Digital input	Coaxial digital input:	0.2 to 2.5 Vp-p
	AES/EBU digital input:	0.2 to 10 Vp-p
	Optical digital input:	-14.5 to -21 dBm
	USB input (Applicable OS)	Microsoft Windows XP (SP2) or later, Mac OS X10.7 or later
	Sampling frequency:	OPT/COAX/AES/ : 32 kHz, 44.1 kHz, 48 kHz, 88.2 kHz, 96 kHz, EBU input: 176.4 kHz, 192 kHz (16 bit, 20 bit, 24 bit) USB input : 32 kHz, 44.1 kHz, 48 kHz, 88.2 kHz, 96 kHz, 176.4 kHz, 192 kHz, 352.8 kHz, 384 kHz (16 bit, 24 bit, 32 bit) 2.8224 MHz, 5.6448 MHz (1 bit)
Digital output	Coaxial digital output:	RCA terminal 0.5 Vp-p/75Ω
	Optical digital output:	Optical digital terminal -15 to -21 dBm
Supplied functions	Front panel	<ul style="list-style-type: none"> • Operation switch • Sampling frequency LED • Bit count display LED • Input selector • Phase selection switch • Filter selection switch (PCM, DSD) • Enter switch • Display switch • Unlock indicator • Digital output display LED • Digital output selection switch
	Rear panel	<ul style="list-style-type: none"> • AC inlet • Digital input terminal (USB, COAX, OPT, AES/EBU) • Digital output terminal (COAX, OPT) • Analog output terminals (BALANCE, UNBALANCE)
Accessories	<ul style="list-style-type: none"> • Owner's Manual • Install software CD • Safety cautions 	
Power supply	AC230 V (50 Hz)	
Power consumption	17 W	
Weight	11.0 kg (main unit)	
Dimensions	440 (W) × 92 (H) × 400 (D) mm (front side knob of 14 mm and rear side terminal of 6 mm included in depth)	

* Specifications and appearance are subject to change without notice.

Before Asking for Repair

While the unit is used, an unusual phenomenon may be confused as a malfunction for a certain reason. Prior to asking us for repair services, please check the table below and read the instruction manual for the subsidiary devices. If the cause of malfunction cannot be identified, please make queries to the purchasing store. When we have once accepted your request for repair services, inspection fees and traveling expenses may be claimed even though the unit is found to be normal.

Besides, such personal computer as a PC/Mac connected to the unit and the software that operates on the PC/Mac (operations and settings included) are not supported.

Problem	Cause/Solution	Ref. page
No power is supplied even though the operation switch is pressed.	· Connect the power cable to the AC inlet (AC IN) and the AC outlet firmly.	11
No sound is generated. / Sound volume is too low.	· Connect the input devices, amplifier, and speakers correctly.	10 - 12
	· Set the input selector to the source to be reproduced.	13
	· When you are listening to the sound of a line output (unbalanced) or a balanced output, adjust the sound volume with the volume control of the connected amplifier.	13
No sound is generated. / Sound volume is too low. (Digital input)	· Connect digital cables correctly.	10 - 12
	· If the USB is selected as an input source, select this unit (DA-06) as the output destination by configuring the sound setting of a PC/Mac.	Refer to the instruction manual of the PC/Mac or the software in use.
	· If the unit (DA-06) cannot be selected even when trying the solution above, reconnect the USB cable.	
	· If the USB is selected as an input source, adjust the sound volume by configuring the sound setting of a PC/Mac.	
	· If the USB is selected as an input source, adjust the sound volume on a player software of a PC/Mac.	
	· Ensure that the sampling frequency and the number of quantization bits of the reproduced digital signal are applicable to this unit.	8 - 9
· Ensure that the digital signal unlock indicator (UNLOCK) does not light up. (When the digital signal from the digital device is not synchronized with this unit, the source may not be reproduced.)	7	
Humming sound (boon or zzz noise) is generated.	· Insert the RCA pin-plugs of the line cables firmly.	10
	· Induction noise may be picked up from the power transformer of another device. Install this unit distantly from the other device."	
	· When you are listening to the sound of a headphone, arrange the headphone cable and the power cable so that they are not laid too close.	

This unit may not work normally when the unit is subject to external influence such as static electricity.

In such a case, normal operation may resume by turning off the power once and turning on the power again after several tens of seconds. If the problem is not solved, please contact your dealer or our service center.

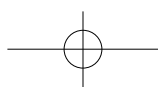
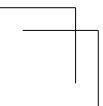
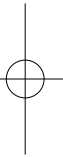
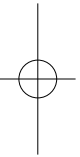
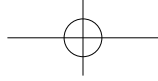
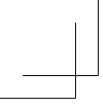

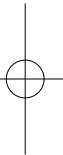
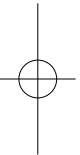
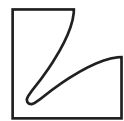
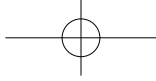

LUXMAN CORPORATION, JAPAN

AG00987E05A
Printed in Japan

