

# INTEGRATED STEREO AMPLIFIER E-480



Accuphase Laboratory, Inc.

1

Since the E-303 launching in 1978, the high-power integrated amp is at the core of Accuphase product lineup.

E-480 is a succession model of E-470, it is the 11<sup>th</sup> generation of “Accuphase Core Product”.

Preamplifier section features the further evolved AAVA that enables an accurate volume control.

At power amplifier section, a damping factor is further enhanced with precise and dynamic speaker driving ability.

The preamplifier and power amplifier sections are kept entirely separate, users are able to combine E-480 with other separate systems.

The new E-480 is a new-generation integrated amplifier that comes close to the performance of separate system.

# Differences in front view

E-470



Accuphase Laboratory, Inc.

2

E-480 has a wholly new front panel design including the button array inside the subpanel.

Needle power meter with indication range to -50dB is able to move even at the small volume level less than -60dB.

Sampling Frequency Display has expanded to “MHz” to support the DAC-50.

## Internal view

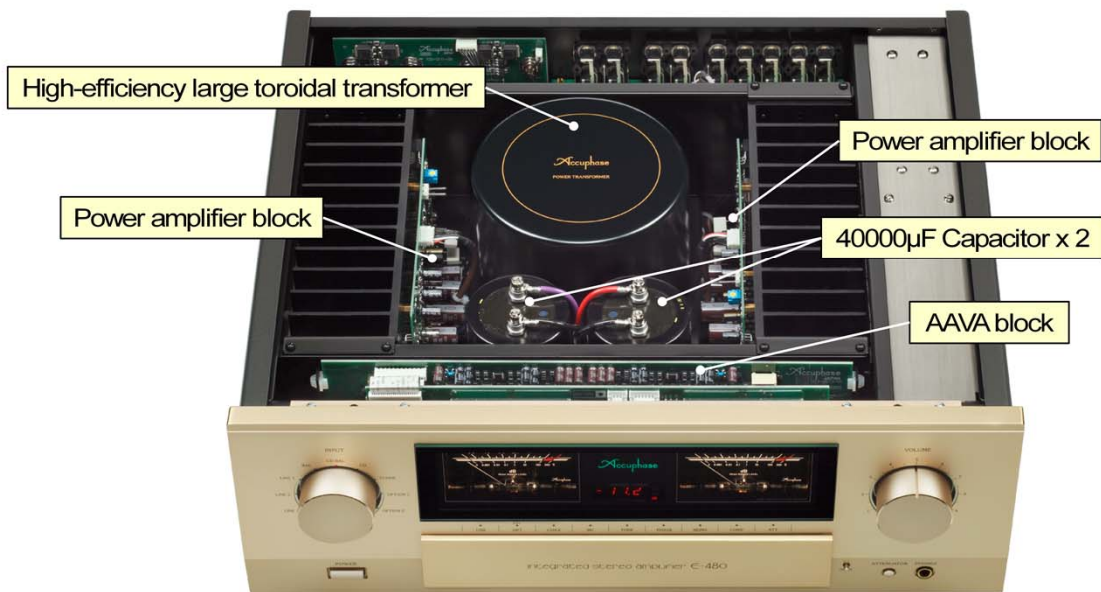

Accuphase Laboratory, Inc.

3

E-480 takes the mono block construction. With the symmetrical arrangement of L / R power amplifier blocks, strong power supply with a massive high-efficiency toroidal transformer and two large 40000µF specially-made filtering capacitors are installed at the center of unit.

AAVA circuit block is located near the front panel.

# Output power

- Class-AB 180W / 8Ω, 260W / 4Ω

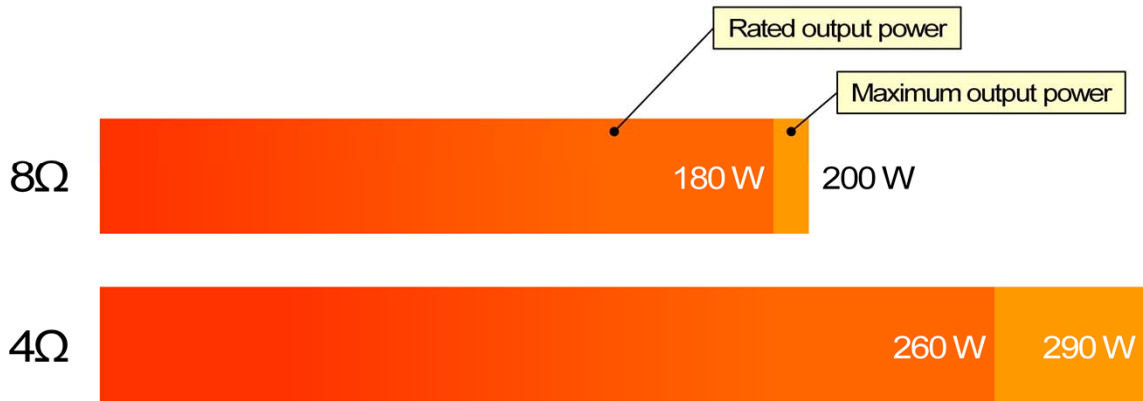

The rated output power of E-480 is 180W into 8Ω load, 260W into 4Ω load. The actual maximum output power achieves 290W into 4Ω load.

These output power figures are same as former model E-470.

# Ultra low noise

- 10% lower than the former model @PRE-OUT
  - S/N ratio: 109dB guarantee

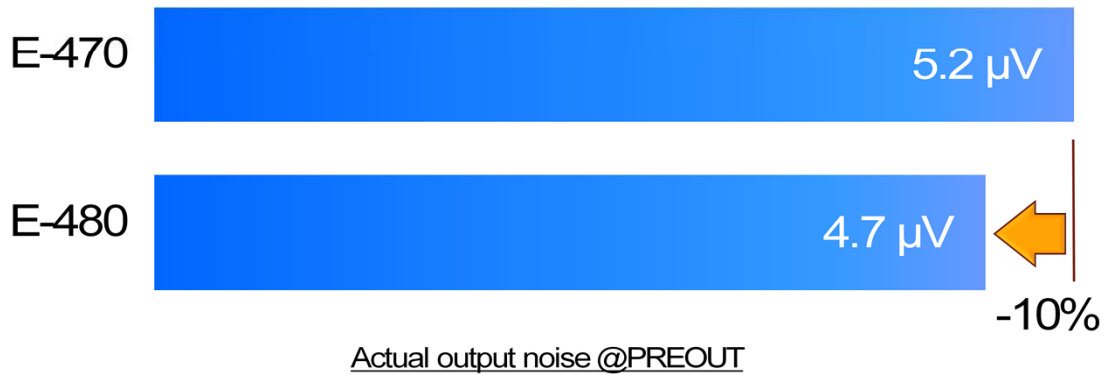

Accuphase Laboratory, Inc.

5

E-480 marks 4.7μV of the actual noise voltage.  
This is 10% lower(1dB) than the former model E-470.

E-480 guarantees 109dB Signal to Noise ratio at the maximum gain.

# Technology for ultra low noise

- Improvement of AAVA
  - Fourth paralleled largest unit, paralleled second largest unit in “V to I” converter

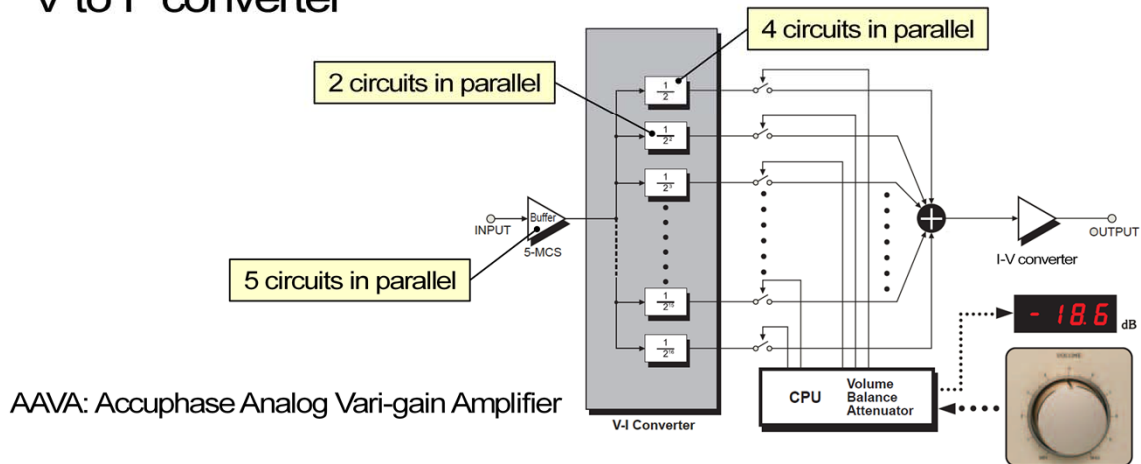

Accuphase Laboratory, Inc.

6

The AAVA (Accuphase Analog Vari-gain Amplifier) is a volume control principle that eliminates all variable resistors from the signal path. This is Accuphase unique technology.

The AAVA module in E-480 achieves low noise by the fourth paralleled largest unit and the paralleled second largest unit in “V to I” converters.

This improvement helps to make the V-I converter amp's output current double, and it results in reducing the value of the feedback resistors and the noise coming from them.

\* The AAVA module in the former model E-470 has paralleled the largest two units in “V to I” converters.

## Super high Damping Factor(D.F.)

- 20% higher than the former model



Guaranteed D.F.

Accuphase Laboratory, Inc.

7

E-480 guarantees 600 of Damping Factor.  
It is 20% higher than the former model E-470.

**\*\*Damping Factor:**

A index of speaker driving ability.

Higher Damping Factor amplifier has higher speaker driving ability.

D.F. =  $8\Omega$  / Output-impedance



# Technology for super high D.F.

- Power amplifier
  - Same circuit configuration as Class-A Stereo Power amp A-75
  - Output stage with triple parallel push-pull power MOS-FETs

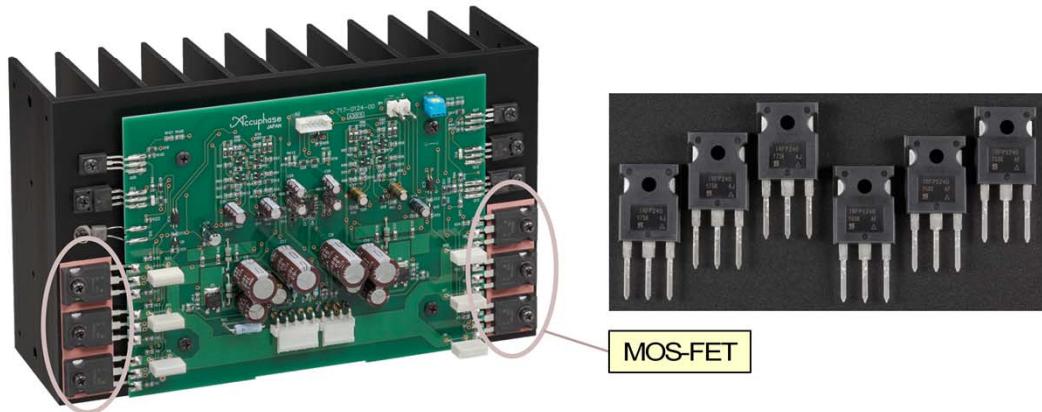

Accuphase Laboratory, Inc.

8

Power amplifier sections contain same circuit configuration as Class-A stereo power amp. A-75.

The output impedance is decreased by 3 parallel push-pull final stage arrangement of MOS-FETs.

E-480 mounts the new power MOS-FET device which is heavy-duty and has the large absolute maximum ratings.

\*\*Absolute maximum ratings of power MOS-FET

E-470's MOS-FET: 180V / 10A

E-480's MOS-FET: 200V / 12A

# Technology for super high D.F.

- Balanced Remote Sensing
  - Feedback from nearby speaker terminals
  - Signal-line and GND-line sensing

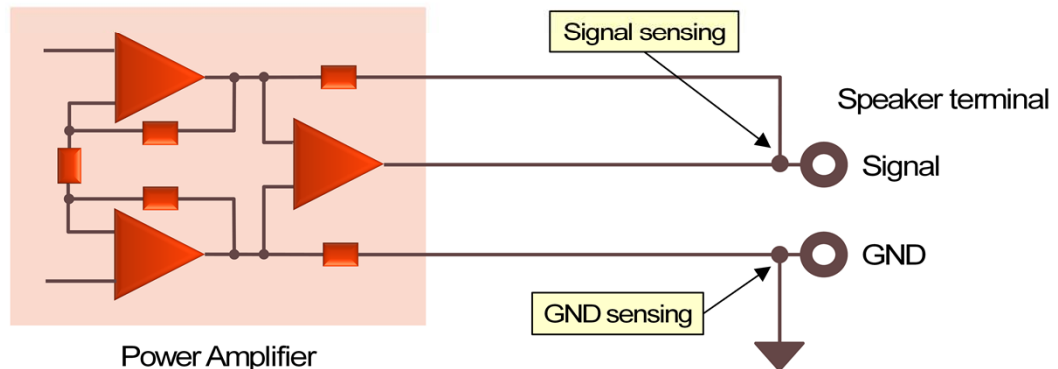

Accuphase Laboratory, Inc.

9

Remote Sensing is the technique to lower the output impedance of amplifier by the negative feedback with signal sensing from nearby the speaker terminals.

Balanced Remote Sensing is the technique to make the output impedance even lower by both the signal sensing and the GND sensing, that is the negative feedback of GND level.

Not only Damping Factor, but also Total Harmonic Distortion and Intermodulation Distortion are all improved by the Balanced Remote Sensing.

# Technology for super high D.F.

- Speaker protection equipped with MOS-FET switch
- Short signal path configuration

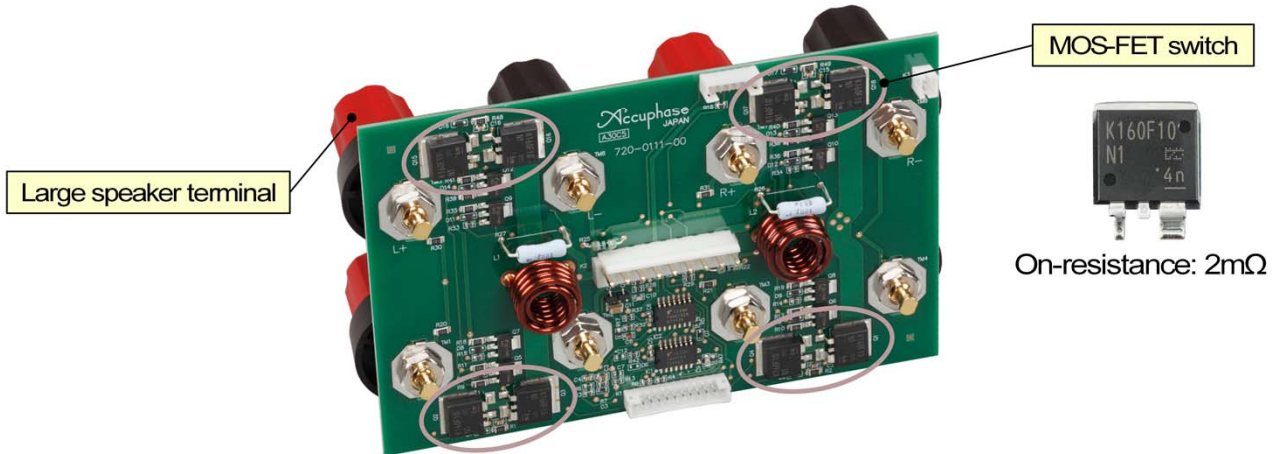

Accuphase Laboratory, Inc.

10

Although a mechanical relay is the most popular component for speaker protection, it does not have high reliability and low contact resistance either.

E-480 applies a MOS-FET switch instead of mechanical relay for speaker protection.

Damping-Factor, reliability and sound quality are all improved by MOS-FET switch.

E-480 was adopted a new MOS-FET which has very low on resistance of 2.0mΩ. (E-470 used 2.6mΩ on resistance MOS-FET)

By connecting speaker terminals and PC-board directly, signal path can be made shorter to obtain the low impedance.

# Pursuing further product safety and reliability

- Power amplifier
  - Newly-developed protection circuit using Photo-couplers
  - Temperature-sensors are installed on both heat sinks

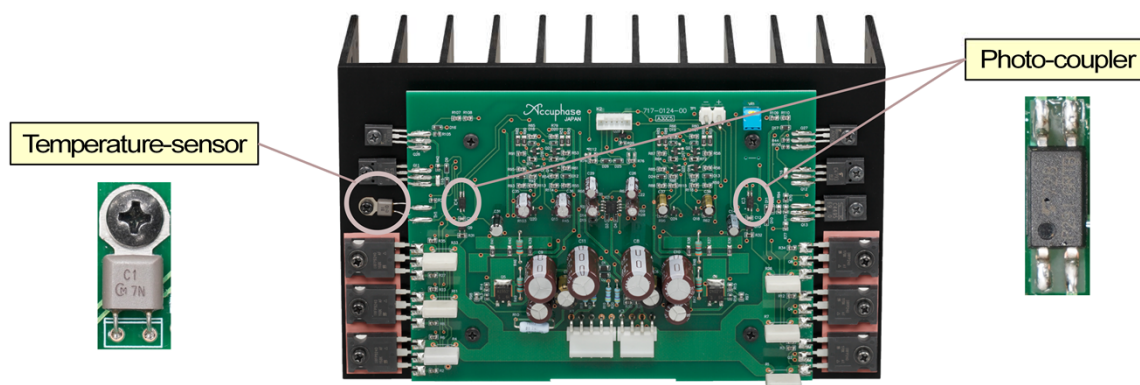

Accuphase Laboratory, Inc.

11

To enhance the further product safety and reliability, E-480 improves the protection circuit on Power amplifier section.

- Newly-developed protection circuit  
Over current protection circuit using photo-coupler is applied, it does not affect the sound quality at all.
- Temperature-sensor  
Temperature-sensors which detects the heat sink temperature are installed on L / R both heat sinks one by one (E-470: 1 sensor on chassis only). Thanks to this, the unit accurately ascertains the high temperature alarm in power amplifier section.

\*\*When these protection circuits are activate, the unit completely interrupts speaker output and makes the power meters flash to indicate an abnormal condition.

# Pursuing sound quality

- Failure teaches success!!



Just a few examples of E-480 trial parts

Accuphase Laboratory, Inc.

12

When embarking on the design of a product, we have a certain concept of the sound that we want to achieve, and this guides us in deciding on circuit topology, parts selection, and physical construction. But in many cases, it will not be possible to realize the original sonic concept right away.

By changing the combination of parts, their physical layout, and various other factors, we adjust the sound and work towards bringing it closer to our goal.

Accuphase engineers devoted much time to do repeated listening test for the technical development.

The picture shows a few examples of trial parts during E-480 development.